

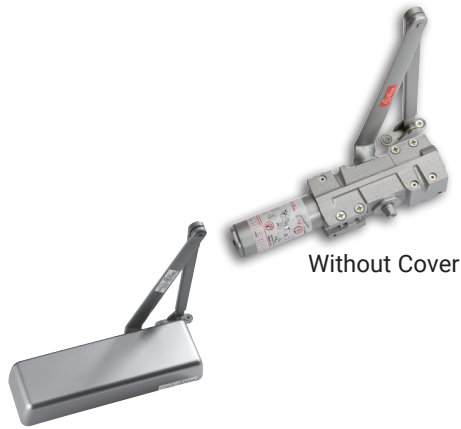

Institutional Full Featured Closer Grade 1

7100 Series

7100 Series



Without Cover

Pivot Stop Arm



The Pivot Stop Arm (PS) is designed to serve as a medium-duty door stop for situations where a door stop or overhead stop is not practical. PS uses backcheck to slow the door and a stop that is integrated into the closer arm to limit the travel of the door (integral stop). PS is available in Regular and Top Jamb mounting. Templating is available for opening angles from 85 - 100 degrees in 5-degree increments.

Spring Cushion Stops



630 SATIN STAINLESS STEEL



613E DARK OXIDIZED SATIN BRONZE (EQUIVALENT)



605 BRIGHT BRASS

PDQ's SCS Series Spring Cushion Stop helps reduce wear and tear on the opening. As the door begins moving through backcheck to its maximum opening angle, the stop acts as a shock absorber, dampening the impact forces.

Specifications



BODY:	• High Strength Cast Iron
ARMS:	• Forged steel main arm
ARM OPTIONS:	<ul style="list-style-type: none"> • PA – Parallel Arm • HO – Hold Open • DS/DSHO – Heavy Duty Parallel Stop • SCS/SCSHO – Spring Cushion Stop for DS/DSHO • TA/TAHO – Track Arm • EDA/EDAHO – Extra Duty Parallel Arm
PISTON:	• 1-1/2" diameter
ADJUSTMENT:	<ul style="list-style-type: none"> • Hydraulic controlled closing • Hydraulic backcheck standard • Backcheck positioning valve standard (starts backcheck snubbing sooner) • Optional delayed action (in addition to backcheck)
ADJUSTMENT VALVES:	• All Adjustment Valves are STAKED to prevent removal during adjustment.
SIZE:	• Adjustable BF through 6
MOUNTING RETROFIT:	<ul style="list-style-type: none"> • Mounting hole pattern retrofits LCN[®] 4040 • Tri-packed for regular, top jamb and parallel arm installations • Includes sex nuts/bolts and screws for wood/metal doors/frames • Self drilling self tapping screws standard • Separate limiting stop may be required for high abuse applications
COVER:	• Full plastic cover standard, optional full metal cover available
COLOR & ARCHITECTURAL FINISHES:	• 605 – Polished Brass, 625 – Polished Chrome, 689 – Aluminum, 693 – Black, 695 – Duro Bronze, 696 – Gold
WARRANTY:	• Twenty-five (25) year Limited Warranty
CERTIFICATIONS, LISTINGS, COMPLIANCES:	<ul style="list-style-type: none"> • UL listed for labeled swinging fire doors rated up to and including 3 hours • Certified to ANSI/BHMA A156.4 Grade 1 • Complies with ADA (Americans with Disabilities Act) and ICC/ANSI 117.1 for Accessible and Usable Buildings • TAA compliant. Country of origin: KR

Finishes

Architectural



605 (US3)
Bright Brass



625 (US26)
Bright Chromium

Painted



689 (US28)
Aluminum



693
Black



695
Dark Duranodic
Bronze



696
Gold

Finishes shown are representative only. PDQ cannot guarantee that product shipped will match finishes shown.

Not all products are available in all finishes listed.

Typical Applications

- Assisted Living
- Higher Education
- High Use/High Abuse Situations
- K-12 Education
- Military and Government
- Multi-family
- Offices
- Public Buildings



Features

- High strength cast iron body and forged steel arm assembly provide maximum durability and reliability in the most brutal environments
- Backcheck positioning valve feature provides a consistent backcheck snubbing range for regular, top jamb and parallel arm applications, preventing costly damage during forceful opening of the door
- The 7100 series has a fully adjustable spring range that can be set to meet barrier free requirements
- Maximum 3" reveal for Top Jamb.
- Heavy duty, fully featured architectural style door control

How to Order

QUANTITY	SERIES	DELAYED ACTION	BACKCHECK	ARM TYPE	FINISH	ACCESSORIES
10	71	01	BC	PA	689	—
		01 – Non-Delayed Action 41 – Delayed Action (In Addition To Backcheck)	BC – Adjustable Hydraulic Backcheck	DS – Door Saver Arm DSHO – Door Saver Hold Open Arm EDA – Extra Duty Arm EDAO – Extra Duty Arm Hold Open HO – Hold Open, Tri-Pack PA – Tri-Pack (standard) SCS – Spring Cushion Stop SCSHO – Spring Cushion Stop Hold open TA – Track Arm TAHO – Track Arm Hold Open	605 – Polished Brass 625 – Polished Chrome 689 – Aluminum 693 – Black 695 – Duro Bronze 696 – Gold	BP – Back Plate BS – Blade Stop Spacer DPPA – Parallel Arm Drop Plate DPTJ – Top Jamb Drop Plate FCM – Full Metal Cover specify hand NFB – Narrow Frame Bracket SDST – Self Drilling Self Tapping Screws

Size Selector

APPLICATION	CLOSER SIZE	INTERIOR	EXTERIOR
Regular / Top Jamb	 BF	5 lbf (36" door)	NA
	1	32"	28"
	2	36"	32"
	3	42"	36"
	4	48"	42"
	5	54"	48"
	6	58"	54"
Parallel Arm	 BF	5 lbf (36" door)	NA
	1	28"	NA
	2	32"	28"
	3	36"	32"
	4	42"	36"
	5	48"	42"
	6	54"	48"

Note: 7100 Series Closers can be adjusted to meet ADA barrier free applications. Strict compliance with ADA barrier free requirements may result with door not fully closing and latching. Check with local AHJ. Closer sizes may vary due to site conditions.

Cross Reference

MANUFACTURER	PDQ	CAL ROYAL	CORBIN/RUSSWIN®	DORMA	FALCON	HAGER	DORMA COMMERCIAL	LCN®	NORTON®	SARGENT®	ACCENTRA
SERIES	7100	CR441	DC8000	8900	SC70	5100	QDC100	4040	7500	281	5800/4400
MOUNTING HOLE PATTERN RETRO-FIT	YES	YES	NO	NO	—	YES	—	NO	NO	NO	NO

Information on this sheet is compiled from public documents and third parties. As a result, PDQ makes no guarantees as to their accuracy, content, quality or availability. Comparisons were made using the technical features only and are not commercial comparisons. Final suitability should be determined by a professional hardware consultant.

Mounting Position

Regular Arm

Regular arm mount is a pull side application with double lever arm. The closer mounts on the door and the arm mounts to the frame. It provides the most efficient operation for a door control and is commonly used on in-swing doors from corridors or other interior doors. Regular arm mount is a poor choice for exterior out-swinging doors as it would put the closer on the exterior of the building. The arm assembly projects directly out from the frame. That may be a concern for vandalism or aesthetics. Regular arm application can be used with non-hold open or hold open arms.

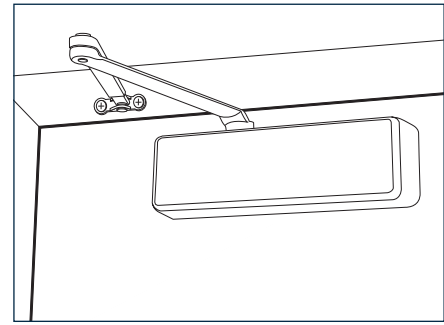

Top Jamb

Top jamb mount is a push side double lever arm application that offers the best alternative to regular arm mount. The closer mounts to the frame and the arm mounts to the door. This application is commonly used on exterior out-swinging doors. It is a poor application for in-swinging doors from a corridor as it places the closer arm in a visible application projecting into the corridor. The arm projects out similar to regular arm mount. Therefore, it can be a concern for vandalism or aesthetics. Top jamb application can be used with non-hold open or hold open arms.

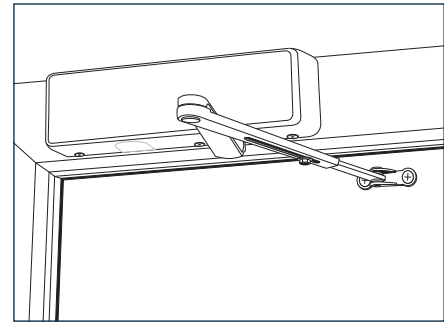

Parallel Arm

Parallel arm mount is a push side double lever arm application. The closer is installed on the push side of the door and the arm is mounted to a parallel arm adapter plate installed to the frame soffit. The arm is approximately parallel with the face of the door, eliminating the projection condition evident with regular arm and top jamb applications. Parallel arm is often preferred where aesthetics or vandalism are concerns. Parallel arm is less efficient than regular or top jamb mounts due to the geometry of the arm. Parallel arm application can be used with non-hold open or hold open arms.

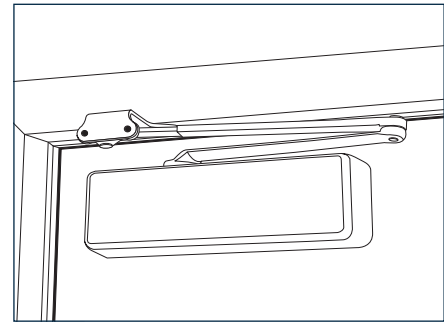

Parallel Arm (DS/DSHO) Stop Arm Extra Duty Arm (EDA/EDAHO) Arm

The parallel stop arm mount is an enhanced version of the parallel arm application. It is similar to the parallel arm mount but incorporates a heavy duty rigid arm and soffit plate with limiting dead stop. The dead stop feature is field handed. The closer's backcheck function should be adjusted to cushion the impact of the stop. The parallel stop arm is intended for use where an auxiliary stop cannot be utilized. The parallel stop arm is available in non-hold open (DS) and hold open (DSHO) applications.



Recommend using the SCS Spring Cushion Stop for moderate to high abuse installations.

For Extra Duty PA Arm applications, specify EDA or EDAHO. Similar to DS/DSHO without the stop. Requires separate limiting stop by others.

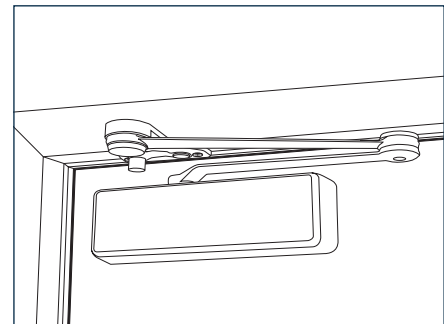

Track Arm (TA)

The non-handed track arm mount incorporates a single forged main arm for installation in high use, high abuse door applications. Its low profile helps prevent damage.

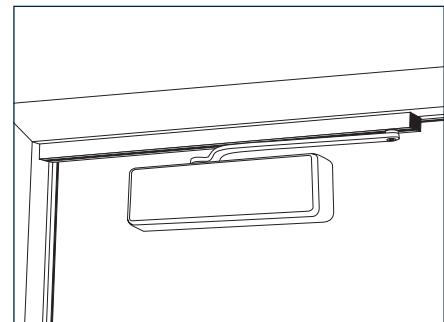

Arms

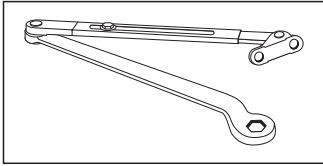

RA - REGULAR ARM

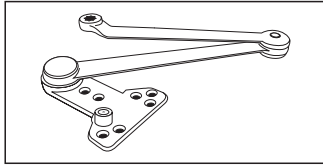

DS - Door Saver (Limiting Stop) Arm

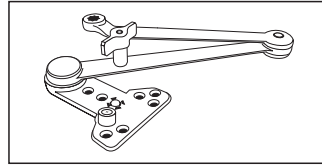

DSHO - DOOR SAVER (LIMITING STOP) HOLD OPEN ARM

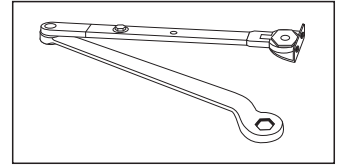

HO - Hold Open Arm

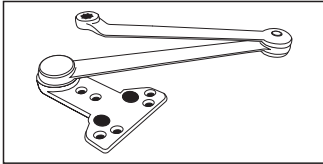

EDA - EXTRA DUTY ARM

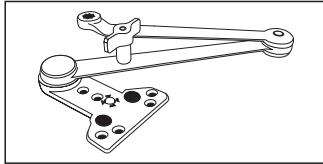

EDAHO - EXTRA DUTY ARM HOLD OPEN

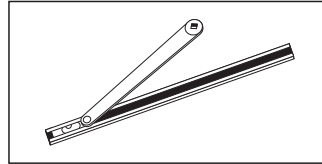

TA - TRACK ARM ASSEMBLY

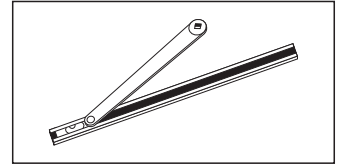

TAHO - TRACK ARM HOLD OPEN

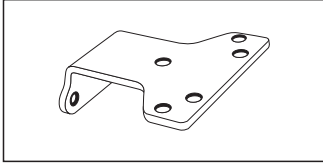

PA - PARALLEL ARM BRACKET

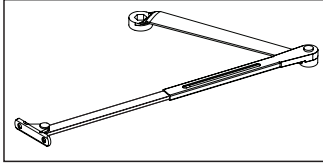

ELR - EXTENDED ARM

Accessories

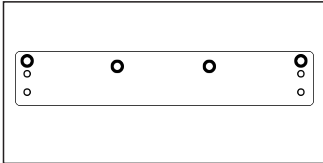

BP - BACK PLATE

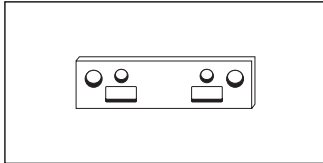

BS - BLADE STOP SPACER

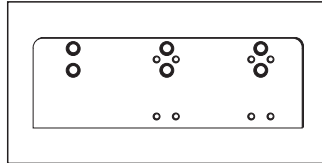

DPTJ - TOP JAMB DROP PLATE

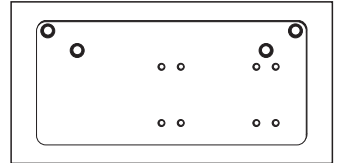

DPPA - PARALLEL ARM DROP PLATE

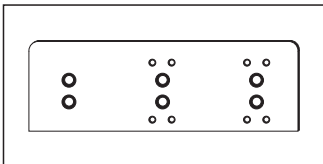

BPTJ - TOP JAMB BACK PLATE

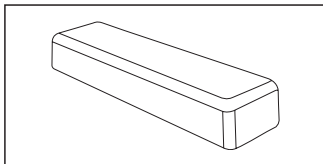

FCM - FULL METAL COVER

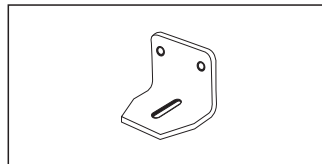

NFB - NARROW FRAME BRACKET

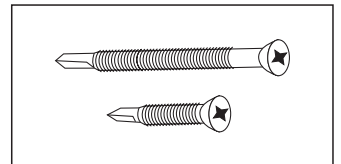

SDST - SELF DRILLING SELF TAPPING SCREWS

Mounting Plates

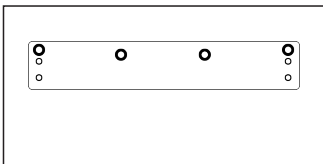

BP - BACK PLATE

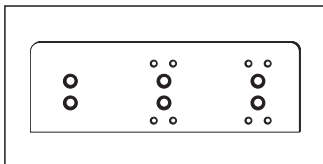

BPTJ - TOP JAMB BACK PLATE

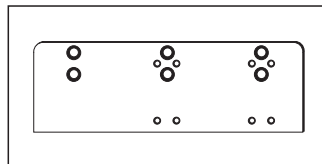

DPTJ - TOP JAMB DROP PLATE

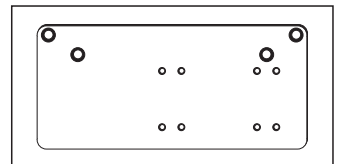

DPPA - PARALLEL ARM DROP PLATE

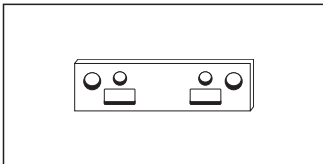

BS - BLADE STOP SPACER

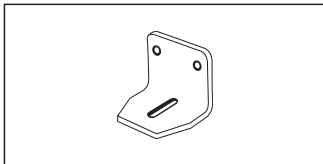

NFB - NARROW FRAME BRACKET

Covers

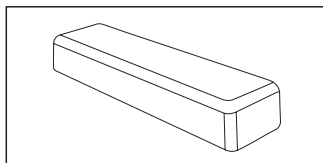

FC - FULL PLASTIC COVER

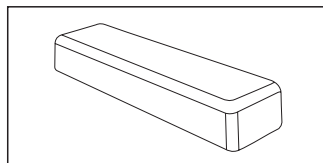

FCM - FULL METAL COVER

Suggested Architectural Specifications

All door closers shall be PDQ Industries, Inc. 7100 Series with full rack and pinion construction, heavy duty cast iron closer body, forged steel main arm and full architectural cover. Hydraulic control shall be through separate hex key non-critical sweep, latch and backcheck valve adjustment. Backcheck positioning valve to provide consistent backcheck range on parallel arm applications. Optional delayed action (in addition to backcheck) to be effective from maximum opening to approximately 70 degrees. Closers shall be non-handed, suitable for regular, top jamb and parallel arm applications with fasteners for wood and metal doors and frames. Sex nuts and bolts shall be furnished standard. Spring adjustment to be provided throughout a range of sizes to include Barrier Free plus sizes 1-6 and capable of meeting barrier free force restrictions. All products to carry a 25-year manufacturer's limited warranty. Closers shall be listed by U.L./U.L.C., comply with UL 10C and UBC 7-2 (1997) for positive pressure and certified to ANSI A156.4 Grade 1.



SECURING CONFIDENCE OPENING POSSIBILITIES

Phone: 717.656.4281

Tech Support: 800.441.9692

Email: help@pdqlocks.com

Headquarters: 2230 Embassy Drive, Lancaster, PA
17603 P.O Box 6426, Lancaster, PA 17607

Regional Distribution Centers: Lancaster, PA | Norcross,
GA | Auburn, WA

Middle East Manufacturing: Dammam, Kingdom of
Saudi Arabia