



**Trimco**<sup>®</sup>  
SINCE 1949

**FULL LINE CATALOG**  
**2018**

## Customer Service & Orders

Monday - Friday Hours: 6:30a to 4:00p PST

T:323.262.4191

F:800.637.8746

E: [csr@trimcohardware.com](mailto:csr@trimcohardware.com)

## Literature

E: [info@trimcohardware.com](mailto:info@trimcohardware.com)

## Quotes

F: 877.786.8387

E: [quotes@trimcohardware.com](mailto:quotes@trimcohardware.com)

## Technical Support

E: [techsupport@trimcohardware.com](mailto:techsupport@trimcohardware.com)

## Comments & Kudos

E: [tellus@trimcohardware.com](mailto:tellus@trimcohardware.com)

## Headquarters

1351 Rocky Point Drive

Oceanside, CA 92056

# INDEX BY PRODUCT CATEGORY



- A. AP SERIES Architectural Pulls
  
- B. Barn, Pocket + Sliding Door Solutions.
  
- C. fOCAL, Classic Products + Modern Masterpieces
  
- D. Lockdown Hardware
  - Flush Bolts + Strikes
  - Locking + Latching
  - Roller Latches + Ball Catches
  - Surface, Cane + Cremone Bolts
  - Hospital Latches
  - Crash Chains + Door Guards
  - Lock Astragals + Accessories
  
- E. Push/Pull Plates, Grips + Bars
  - Push Plates
  - Pull Plates
  - Grips + Pulls
  - Push/Pull Bar Sets
  - Anti-Vandal Pulls
  - Flush Pulls
  
- F. Door, Wall + Frame Protection
  - Stops + Holders
  - Silencers
  - Kick + Armor Plates
  - Coordinators
  - Specialty Plates
  - Latch, Panic, Edge + Frame Guards
  - Door Caps
  
- G. Accessories + Other Products
  - Signage
  - Door Viewers + Knockers
  - Mail Plates
  - Cabinet Pulls, Knobs + Catches
  - Coat Hooks
  - Handrail Brackets
  - Finger Guards

# INDEX BY PART NUMBER



PART	PAGE	PART	PAGE	PART	PAGE
FINISHES	1	KE37-1	G-9	562-4	E-1
NOTES	2	KE38-1	G-9	562-96mm	E-1
MOUNTING	3	KH050	G-8	571-3	E-1
ABERDENE x	C-4	KM038	G-8	571-6	E-1
VELAZQUEZ	C-4	KM038-1	G-8	571-8	E-1
ABERDENE	C-4	KM050	G-8	571-10	E-1
AP100 SERIES	A-1	KM050-1	G-8	620	G-4
AP100 SERIES	A-2	KS050	G-8	621	G-4
AP200 SERIES	A-3	LDH100-PHI	D-1	625CV	G-4
AP200 SERIES	A-4	LDH100-VD	D-1	625CVE	G-4
AP300 SERIES	A-5	LDH100-DM	D-1	625V	G-4
AP300 SERIES	A-6	MLDHVD00013	D-1	625VE	G-4
AP400 SERIES	A-7	PBT8000-1-X	G-7	751	G-2
AP400 SERIES	A-8	PBT8000-2-X	G-7	752	G-2
AP500 SERIES	A-9	PG8000	G-6	753	G-2
AP500 SERIES	A-10	PG8002	G-6	754	G-2
AP600 SERIES	A-11	PG8002-1	G-6	755	G-2
AP600 SERIES	A-12	PG8125VV-1	G-7	756	G-2
AP700 SERIES	A-13	PG8125VV-4	G-7	757	G-2
AP700 SERIES	A-14	WS SERIES	B-1	758	G-2
APC20 SERIES	A-15	15	C-3	760	G-3
APC30 SERIES	A-16	16	C-3	771	G-3
BP1	E-1	17	C-3	773	G-3
BP2	E-1	18	C-3	774IBC	G-3
BP3	E-1	35	C-3	775IBC	G-3
BP4	E-1	50	C-3	793	G-3
FG8000-XX	G-7	51	C-3	802	D-4
K39	G-7	57	C-3	804	D-4
K0038	G-8	58	C-4	810	D-4
K0050	G-8	59	C-4	975	G-4
K6000	G-8	111	C-4	975L	G-4
KA038	G-8	242	E-7	975U	G-4
KA038-1	G-8	243T	D-4	976	G-4
KA050-1	G-8	244B	D-4	976U	G-4
KA050-2	G-8	248	E-7	1001-1	E-2
KA050-3	G-8	507	G-1	1001-2	E-2
KE31-1	G-9	508	G-1	1001-3	E-2
KE32-1	G-9	509	G-1	1001-3P	E-2
KE33-1	G-9	527	G-1	1001-9	E-2
KE33-2	G-9	528	G-1	1001-11	E-2
KE34-1	G-9	529	G-1	1010-1	E-2
KE35-1	G-9	553	E-1	1010-2	E-2
KE36-1	G-9	562-3	E-1	1010-3	E-2

# INDEX BY PART NUMBER



PART	PAGE	PART	PAGE	PART	PAGE
1012-2	E-2	1069 SERIES	B-2	1183-1/CAIRO	E-9
1012-3	E-2	1069 SERIES	B-3	1191-1	E-9
1013-2	E-3	1070-2	C-4	1191-2	E-9
1013-2B	E-3	1071-2	C-4	1191-3	E-9
1013-3	E-3	1074 SERIES	B-2	1191-4	E-9
1013-3B	E-3	1074 SERIES	B-3	1191-4J	E-9
1014-2	E-3	1082-4	E-18	1191-5	E-9
1014-2B	E-3	1082-6	E-18	1191-5J	E-9
1014-3	E-3	1082-8	E-18	1193-1	E-9
1014-3B	E-3	1096HA	E-19	1193-2	E-9
1015-2	E-3	1096-PHI	E-19	1194-1	E-10
1015-2B	E-3	1096-PHI-NC	E-19	1194-2	E-10
1015-3	E-3	1096TL	E-18	1194-3	E-10
1015-3B	E-3	1096VD98-99HA	E-19	1194-4	E-10
1017-2	E-4	1097HA	E-19	1195-1	E-10
1017-2B	E-4	1097-PHI	E-19	1195-2	E-10
1017-3	E-4	1097-PHI-NC	E-19	1195-3	E-10
1017-3B	E-4	1097TL	E-18	1195-3J	E-10
1017-3C	E-4	1097VD98-99HA	E-19	1195-6	E-10
1018-2	E-4	1098RG	E-18	1195-6J	E-10
1018-2B	E-4	1099RG	E-18	1198-1-XX	E-1
1018-3	E-4	1102S	E-2	1199-1	E-10
1018-3B	E-4	1102T	E-2	1199-2	E-10
1056-4	E-4	1109-1	E-2	1200	F-1
1059	E-5	1110-8	E-6	1201	F-1
1060	E-5	1110-10	E-6	1201-5	F-1
1061	E-5	1110-18	E-6	1201CK	F-1
1062	E-5	1110-CUST	E-6	1204	F-1
1063	E-5	1111A	E-7	1205	F-1
1064	E-5	1111B	E-7	1206	F-1
1064FCP	E-5	1111C	E-7	1207	F-1
1065	E-5	1115	E-7	1208	F-1
1065CD	E-5	1113	E-7	1209	F-1
1065PA	E-5	1117-1	E-8	1209HA	F-2
1066S	E-6	1120	E-8	1211	F-2
1066S-516	E-6	1134	E-8	1211CH	F-2
1066S-38	E-6	1135	E-8	1211CL	F-2
1067	E-6	1136	E-8	W1211	F-2
1067-516	E-6	1139-1	E-8	1214	F-2
1067-38	E-6	1139-2	E-8	1214H	F-2
1068	E-6	1147	E-8	1214CK	F-2
1068-516	E-6	1150	E-9	1214CKx1268CK	F-2
1068-38	E-6	1151	E-9	1215CKU	F-3

# INDEX BY PART NUMBER



PART	PAGE	PART	PAGE	PART	PAGE
1217P	F-3	1270WV	F-8	1633	E-20
1217S	F-3	1270CX	F-8	1637	E-20
1220-5	F-3	1270WX	F-8	J1637	E-20
1221-4	F-3	1275CVPV	F-8	1640 SERIES	E-17
1221-4FF	F-3	1270CVSV	F-8	1661	E-20
1223	F-3	1275RP	F-8	1662	E-20
1224	F-3	1277/79	F-8	1698	E-20
1224-5	F-3	1278CV	F-8	1700 SERIES	E-13
1229A	F-4	1278CX	F-8	1700 SERIES	E-14
1229B	F-4	1301	C-1	1700 SERIES	E-15
1229EL	F-4	1310	C-1	1700 SERIES	E-16
1231	F-4	1320	C-1	1748	E-10
1233	F-4	1330	C-1	1748-1	E-10
1234	F-4	1340	C-1	1802-4	E-11
1235	F-4	1350L	C-2	1802-25	E-11
1240	F-5	1358R	C-2	1804-4	E-11
1244	F-5	1360	C-2	1807-4	E-11
1244-6	F-5	1370	C-2	1807-25	E-11
1245	F-5	1380	C-2	1809-4	E-11
1254	F-5	1410	C-2	1820	E-11
1255	F-5	1410-1	C-2	1820-11	E-11
1257M	F-5	1502	D-8	1822	E-11
1257R	F-5	1503	D-8	1822-1	E-11
1258M	F-5	1505	D-8	1822-2	E-11
1260W	F-6	1554	D-4	1894-3	E-12
1261	F-6	1555	D-4	1895-3	E-12
1263	F-6	1555L	D-4	1896-4	E-12
1265	F-6	1559	D-5	2082	G-3
1267	F-6	1559A	D-5	2085	G-3
1260P	F-6	1559BL	D-5	2091	G-3
1260WP	F-6	1559C	D-5	3070-1	G-4
1268	F-6	1559WA	D-5	3071	G-4
1268CK	F-6	1559WB	D-5	3071-1	G-5
L1280	F-7	1559WC	D-5	3072	G-5
L1280CI	F-7	1562A	D-8	3090	D-9
1283-4S	F-7	1562AE	D-8	3092	D-9
1283-2S	F-7	1562Q	D-8	3093	D-9
1283-6S	F-7	1562M	D-8	3094A2	D-9
1290	F-7	1563A	D-8	3094B1	D-9
1291	F-7	1580A	D-8	3094B2	D-9
1296	F-7	1630	E-20	3094B3	D-9
1298	F-7	1630B	E-20	3094B4	D-9
1270CV	F-8	1633-1	E-20	3094C4	D-9

# INDEX BY PART NUMBER



PART	PAGE	PART	PAGE	PART	PAGE
3094D	D-9	4015	G-6	9561	E-12
3094-1	D-9	4016	G-6	9566	E-12
3094-2	D-9	4016ED	G-6		
3094-3	D-9	4016-S	G-6		
3094-4	D-9	4017	G-6		
3094-5	D-9	4048	G-6		
3094-6	D-9	4873	D-3		
3095	D-9	4874	D-3		
3096	D-9	4876	D-3		
3405	G-5	4882	D-3		
3406	G-5	5000-T	G-5		
3651	D-5	5001	G-5		
3652	D-5	5002	G-5		
3810	D-7	5022	G-5		
3815L	D-7	5022A	G-5		
3821	D-7	5004	G-5		
3825L	D-7	7001	C-6		
3830A	D-7	7009	C-6		
3830AL	D-7	7010	C-6		
3830M	D-7	7059	C-6		
3830WL	D-7	7060	C-6		
3850	D-7	7061	C-6		
3900	D-7	7140	C-6		
3910	D-6	7141	C-6		
3910N	D-6	7150	C-6		
3911	D-6	7160	C-6		
3913	D-6	7170	C-6		
W3913	D-6	7180	C-5		
3915	D-6	7181	C-5		
3916	D-6	7191	C-5		
3917	D-6	7196-1	C-5		
W3917	D-6	7196-2	C-5		
3917ET	D-6	7196-3	C-5		
3920-4	D-2	7208	C-5		
3920-8	D-2	7276	C-5		
3921	D-2	W7276	C-5		
3922	D-2	7278	C-5		
3923	D-2	7280	C-5		
3922L	D-2	7281	C-5		
3922NYPV	D-2	7285	C-5		
3828K	D-3	9550	E-12		
3928L	D-3	9551	E-12		
3999SE	D-3	9560	E-12		

# AVAILABLE FINISHES



U.S GOVT.	BHMA	DESCRIPTION
US3	605	Polished Brass, Clear Coated
US3NL*	499*	Polished Brass, No Lacquer
US4	606	Satin Brass, Clear Coated
US5*	609	Satin Brass, Blackened, Satin Relieved, Clear Coated
US7*	610*	Satin Brass, Blackened, Bright Relieved, Clear Coated
US9*	611	Polished Bronze, Clear Coated
US10	612	Satin Bronze, Clear Coated
US10B	613	Dark Oxidized Satin Bronze, Oil Rubbed
US11*	616*	Satin Bronze, Blackened, Satin Relieved, Clear Coated
US15	619	Satin Nickel Plated, Clear Coated
US15A	620	Satin Nickel Plated, Blackened, Satin Relieved, Clear Coated
US19*	622*	Satin Black Coated
US26	625	Bright Chrome Plated
US26D	626	Satin Chrome Plated
US28	628	Satin Aluminum, Clear Anodized
US32	629	Polished Stainless Steel
US32D	630	Satin Stainless Steel
--	630TG	Stainless Steel with Trimguard
--	313	Satin Aluminum, Dark Bronze Anodized
--	335	Satin Aluminum, Black Anodized
--	710CU	Sterralloy - CuVerro Alloy (Standard)

Those finishes with asterisks (\*) are considered “Special” and are available on request. 313 and 335 finishes are available on limited products.

Many other finishes can be furnished on special order, or by quotation.

Note: Finish 613 (US-10B) is considered a living finish and will vary when applied to different alloys or forms of base metal and in the products of different manufacture. Limited shelf life.

Finish 622 (US19), flat black coated, is neither recommended or guaranteed.

## ABBREVIATIONS USED

B - Base	D - Diameter	L - Length	S - Spindle
BHMA - BHMA product #	DP - Depth	M - Material	STR - Strike
BP - Base Projection	E - Engraving	OA - Overall Size	SW - Stop Width
BR - Brackets	F - Finish	OD - Outside Dimension	SYM - Symbol
BS - Backset	G - Grip Style	P - Projection	TH - Throw
CL - Clearance	GP - Grip Projection	PP - Push Plate	W - Width
COL - Color	H - Height	R - Riser	WC - Wall to Center Line
CTC - Center to Center	ID - Inside Dimension	RET - Return Width	CU+ - CuVerro

Combo Pack - Fasteners for both wood, plaster or concrete are included. Abbreviations are also defined at the bottom of each page

Br - Brass, Bz - Bronze, Al - Aluminum, SS - Stainless Steel, Pl - Chrome Plated (Brass or Bronze casting) *The small letters Br, Bz, Pl, SS, Al at the lower right of each product table. Identify the base metal options in which that product is available.*

- *The hardware shown on these pages is made with no compromise in quality, design or durability. Only quality extrusions, sheet stock and castings are used. Careful matching, polishing, assembly and finishing result in a final product that we present with pride.*
- Templates are available on our website, or upon request, for almost every product offered by TRIMCO. Templates are issued only for the project for which they are requested. TRIMCO reserves the right to make design changes without notice. Always request a current template prior to machining doors.
- Our complete in-plant capabilities enable us to produce countless items of a special nature. *Let us quote on any of your hardware needs not shown in this catalog.*
- A large number of exterior pull handles and push/pull bar sets may be adapted for fOCAL styling and are marked “fOCAL option available” in the catalog and price list. Hard black finished style plates of appropriate diameter are provided at all locations where the grip or the base meet door.
- All castings are available in brass, bronze, or aluminum unless otherwise noted.
- The small letters at the lower right of each product table identify the base metal options in which that product is available. Br - Brass, Bz - Bronze, Al - Aluminum, SS - Stainless Steel, Pl - Chrome Plated

## **WARRANTY DISCLAIMER; EXCLUSIVE REMEDY**

WE WARRANT THAT OUR PRODUCTS ARE GENERALLY FIT FOR THE PURPOSE FOR WHICH THEY WERE DESIGNED. PROPERLY SELECTED, PROPERLY INSTALLED AND NOT ABUSED IN USE, THEY WILL SERVE THE PURPOSE FOR WHICH THEY WERE INTENDED. WE DO NOT WARRANT THE MERCHANTABILITY OF OUR PRODUCTS, nor do we offer any other warranty of any kind, expressed or implied, and the customer should not extend any warranty on our behalf to anyone. Any such unauthorized extensions shall be the customer's responsibility. In no event shall we be liable to the customer in warranty, contract, strict liability or otherwise for any damages alleged to be caused by one or more of our products, beyond the cost to the customer of the subject product or products, refund of the purchase price being customer's sole and exclusive remedy against us upon proof of any alleged claim. Incidental and consequential damages, including labor costs relating to installation or removal, shall not be our liability, and customer shall not have remedy against us for such damages, the sole and exclusive remedy for a proven claim having been stated above.

All materials and finishes meet ANSI/BHMA standards at time of shipment. We do not warrant finishes exposed to hostile environments.

Customer is responsible for determining the suitability of our products for customer's use or resale.

# MOUNTING METHODS

## E - Mount

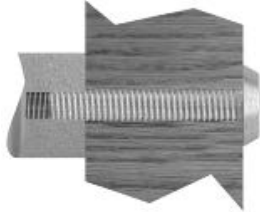

Thru-bolt & Finish Washer  
 3/4" dia. or Less: 1/4-20 Thread 1"  
 dia. or More: 5/16-18 Thread  
 Right Hand Thread (RHT) Standard  
 Left Hand Thread (LHT) Available.

## G - Mount

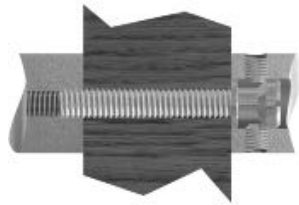

Back-to-Back  
 Threaded Shoulder Bolt & Set Screws (x2)  
 3/4" dia. or Less: 1/4-20 Thread  
 1" dia. or More: 5/16-18 Thread Special  
 Shoulder Bolts. Available.

## J - Mount



Concealed Mounting  
 Threaded Shoulder Bolt & Set Screws (x2)  
 3/4" dia. or Less: 1/4-20 Thread  
 1" dia. or More: 5/16-18 Thread Specify  
 Riv-Nut or Bushing if required. Special  
 Shoulder Bolts. Available

## L - Mount

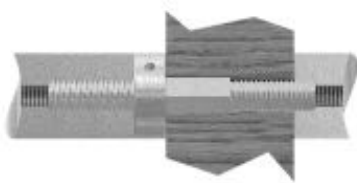

Back-to-Back Concealed Mounting  
 Spanner Turning Washer & Stud  
 For Round Bases  
 Specify Metal, Wood or Glass Doors.

## M - Mount

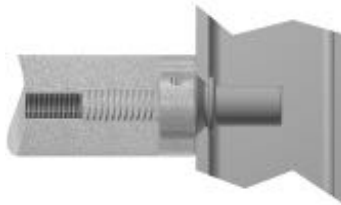

Concealed Mounting  
 Spanner Turning Washer - Single Mount  
 For Round Bases  
 Specify Metal or Wood Doors.

## N - Mount



Thru-bolt with Flow-thru Button  
 Single Mount for Round Bases  
 Right Hand Thread (RHT) Standard  
 Left Hand Thread (LHT) Available.

## W - Mount



Glass Door Kit  
 Includes clear spacer & x2 felt washers  
 Specify glass thickness & hole diameter  
 Requires mounting kit (i.e. N-Mount)

## Riv-Nut



Riv-Nut  
 For J or M Mounting on Aluminum Doors  
 R3: 1/4-20 Thread  
 R4: 5/16-18 Thread  
 R5: 3/8-16 Thread

## Bushing



Wood Thread to Machine Thread  
 For J or M Mounting on Wood Doors  
 B3: 1/4-20 Thread  
 B4: 5/16-18 Thread  
 B5: 3/8-16 Thread

## NOTES

# AP100 SERIES

## ARCHITECTURAL STRAIGHT PULLS



Trimco's AP100 Series Straight Pulls offer a wide variety of products to fit most applications. The AP100 Pull Series is ADA compliant and options include leather wrapped grips, engraving and back-to-back mounting. These Straight Pulls are manufactured from stainless steel, bronze, brass and aluminum to meet any design specification.

- Wide array of material sizes and dimensions to meet any design specification
- Manufactured from stainless steel, bronze, brass and aluminum for durability and long life
- Large range of center-to-center dimensions: 8" to 48"
- Material options include 3/4" round, 1" dia. and 1-1/4" dia
- ADA Compliant
- Leather wrapped options available
- Leather wrap coverage stops 0.5" +/- 0.25" from the pull bend radius
- Additional finish options - contact customer service
- \* For J & M mounting options, specify Riv-Nut for metal doors or bushings for wood doors, if required
- \*\* Glass Door Mounting options for 3/8" & 1/2" door thicknesses require a W-Mount hardware kit



AP100 Architectural  
Straight Pull

# AP100 SERIES

## HOW TO SPECIFY AND ORDER

# AP121G-48-4-B.629

Finish	
605	• Polished Brass
606	• Satin Brass
609	• Antique Brass
612	• Satin Bronze
613	• Oil Rubbed Bronze
622	• Matte Black
628	• Satin Anodized Aluminum
629	• Polished Stainless Steel
630	• Satin Stainless Steel
710	• Healthy Hardware, Satin

Mounting Type	
E	• Thru-Bolt & Finish Washer
G	• Back-to-Back: Threaded Shoulder Bolt & Set Screws
* J	• Concealed: Threaded Shoulder Bolt & Set Screws
L	• Back-to-Back Concealed: Spanner Turning Washer & Stud
* M	• Concealed: Spanner Turning Washer & Stud
N	• Thru-Bolt with Flow-Thru Button

Door Thickness	
0	• Custom
** 1	• 3/8"
** 2	• 1/2"
3	• 1-3/8"
4	• 1-3/4"
5	• 2"
6	• 2-1/4"
7	• 2-1/2"
8	• 3"

Options	
Leather	
B	• Leather - Black
D	• Leather - Dark Brown
L	• Leather - Light Brown
Engraving	
Single Pull	
U	• PUSH
V	• PULL
W	• Other - Customize
BTB Pulls	
X	• PUSH/Interior & PULL/Exterior
Y	• PULL/Interior & PUSH/Exterior
Z	• Other - Customize

Family	Description
<b>AP110: 3/4" Diameter</b>	
AP111	3/4" Diameter, Round Round, Straight Bent Pull
<b>AP120: 1" Diameter</b>	
AP121	1" Diameter, Round Round, Straight Bent Pull
<b>AP130: 1-1/4" Diameter</b>	
AP131	1-1/4" Diameter, Round Round, Straight Bent Pull

Size CTC	
Overall	
12	• 12"
18	• 18"
24	• 24"
36	• 36"
48	• 48"
Or Specify CTC	

# AP200 SERIES ARCHITECTURAL OFFSET PULLS



Trimco's AP200 Series Architectural Offset Pulls are a great compliment to any building design. Trimco's Offset Pulls are ADA compliant and offer options for leather wrapped grips, engraving and back-to-back mounting.

- Wide array of material sizes and dimensions to meet any design specification
- Manufactured from stainless steel, bronze, brass and aluminum for durability and long life
- Large range of center-to-center dimensions: 8" to 48".
- Material options include 3/4", 1" and 1-1/4" diameter
- ADA Compliant
- Leather wrapped options available
- Leather wrap coverage stops 0.5" +/- 0.25" from the pull bend radius.
- Additional finish options - contact customer service
- Specify for custom CTC length
- \* For J & M mounting options, specify Riv-Nut for metal doors or bushings for wood doors if required
- \*\* Glass Door Mounting options for 3/8" & 1/2" door thicknesses require a W-Mount hardware kit



AP200 Offset Bent Pulls

# AP200 SERIES

## HOW TO SPECIFY AND ORDER



# AP231J-18-3-V.613

Finish	
605	• Polished Brass
606	• Satin Brass
609	• Antique Brass
612	• Satin Bronze
613	• Oil Rubbed Bronze
622	• Matte Black
628	• Satin Anodized Aluminum
629	• Polished Stainless Steel
630	• Satin Stainless Steel
710	• Healthy Hardware, Satin

Mounting Type	
E	• Thru-Bolt & Finish Washer
G	• Back-to-Back: Threaded Shoulder Bolt & Set Screws
* J	• Concealed: Threaded Shoulder Bolt & Set Screws
L	• Back-to-Back Concealed: Spanner Turning Washer & Stud
* M	• Concealed: Spanner Turning Washer & Stud
N	• Thru-Bolt with Flow-Thru Button

Door Thickness	
0	• Custom
** 1	• 3/8"
** 2	• 1/2"
3	• 1-3/8"
4	• 1-3/4"
5	• 2"
6	• 2-1/4"
7	• 2-1/2"
8	• 3"

Options	
<b>Leather</b>	
B	• Leather - Black
D	• Leather - Dark Brown
L	• Leather - Light Brown
<b>Engraving</b>	
<b>Single Pull</b>	
U	• PUSH
V	• PULL
W	• Other - Customize
<b>BTB Pulls</b>	
X	• PUSH/Interior & PULL/Exterior
Y	• PULL/Interior & PUSH/Exterior
Z	• Other - Customize

Family	Description
<b>AP210: 3/4" Diameter</b>	
AP211	3/4" Diameter Round, Offset Bent Pull
<b>AP220: 1" Diameter</b>	
AP221	1" Diameter Round, Offset Bent Pull
<b>AP230: 1-1/4" Diameter</b>	
AP231	1-1/4" Diameter Round, Offset Bent Pull

Size CTC	
<b>Overall</b>	
12	• 12"
18	• 18"
24	• 24"
36	• 36"
48	• 48"
Or Specify CTC	

# AP300 SERIES ADJUSTABLE & CONFIGURABLE PULLS



Trimco's AP300 Series Pulls (formerly 1185 Series) are uniquely designed to make the world healthier, while being durable, flexible, and highly customizable.

- Available with Healthy Hardware® Copper Nickel alloy touch surfaces
- Healthy Hardware (710) has an appearance similar to stainless steel
- Adjustable and configurable standoffs are versatile for use across many different center-to-center configurations.
- Configurable and customizable end caps are available in multiple sizes and finishes
- 1-1/2" clearance conforms to ADA requirements for accessibility
- Mid post is recommended for OA's at or greater than 72".
- Standard CTC is OA less 6"
- Can be ordered with standoffs installed (S) or loose (L).
- \*For J mounting option, specify Riv-Nut for metal doors or bushings for wood doors if required
- \*\*Glass Door Mounting options for 3/8" & 1/2" door thickness require W-Mount hardware kit

Formerly 1185 Series



AP300 Pull with Straight Posts



AP300 Pull with Offset Posts

# AP300 SERIES

## HOW TO SPECIFY AND ORDER



# AP316J-76L-4-PJB.630

Mounting Type	
E	• Thru-Bolt & Finish Washer
G	• Back-to-Back: Threaded Shoulder Bolt & Set Screws
J	• Concealed: Threaded Shoulder Bolt & Set Screws

Door Thickness	
0	• Custom
** 1	• 3/8" **
** 2	• 1/2" **
3	• 1-3/8"
4	• 1-3/4"
5	• 2"
6	• 2-1/4"
7	• 2-1/2"
8	• 3"

Optional Mid-Post
P • Midpost
Recommended for Pulls > 72" OA

Finish
<b>AP310 Family</b>
630 • Satin Stainless Steel
710 • Healthy Hardware Satin
<b>AP320 Family</b>
628 • Clear Anodize
313 • Dark Bronze Anodize
335 • Black Anodize

Family	Description
<b>AP310: 1-1/4" Diameter</b>	
AP311	1-1/4" Diameter, Straight Standoffs, 0.5" endcaps
AP312	1-1/4" Diameter, Straight Standoffs, 1" endcaps
AP313	1-1/4" Diameter, Straight Standoffs, 2" endcaps
AP314	1-1/4" Diameter, Offset Standoffs, 0.5" endcaps
AP315	1-1/4" Diameter, Offset Standoffs, 1" endcaps
AP316	1-1/4" Diameter, Offset Standoffs, 2" endcaps
<b>AP320: 1-1/4" Diameter, Aluminum, Square Ends</b>	
AP321	1-1/4" Diameter, Straight Standoffs, Square Ends
AP324	1-1/4" Diameter, Offset Standoffs, Square Ends

Size OA/CTC	
Overall	CTC
18 • 18"	S • Standard
30 • 30"	L • Loose
42 • 42"	
Or Specify OA/CTC	

Endcap Options	
Finish	Insert
<b>AP310 Family</b>	
A • 710	B • Black
B • 605	N • None
C • 606	
D • 609	
E • 611	
F • 612	
G • 613	
H • 628	
I • 629	
J • 630	
K • 335	

# AP400 SERIES ARCHITECTURAL LADDER PULLS



Trimco's AP400 Series Ladder Pulls add style and sophistication to any opening. A multitude of options enable customization and flexibility to enhance surrounding building aesthetics.

- Manufactured from stainless steel, bronze, brass or aluminum for long-lasting durability
- Flexibility in design from straight or offset pulls to square or radius ends
- Wide range of lengths available from 12" to over 9'
- Available in most architectural finishes
- Multiple mounting options for metal, wood and glass doors.
- ADA compliant
- Standard CTC (based on OA): Shorter than 24" is OA less 4" and greater than 24" OA less 6"
- Mid-post is recommended for CTC's of 84" or greater
- Specifying Custom Pull Sizes (CTC) –
  - Example 1 • 35" OA, 29" CTC, specify as 3529
  - Example 2 • 11" OA, 7" CTC, specify as 1107
- 710 finish is only available for the AP420 Family (1-1/4" dia)
- \* For J & M mounting options, specify Riv-Nut for metal doors or bushings for wood doors if required
- \*\* Glass Door Mounting options for 3/8" & 1/2" door thicknesses require a W-Mount hardware kit

Formerly 1160 &  
1170 Series



AP400 Offset Ladder Pull



AP400 Straight Ladder Pull

# AP400 SERIES

## HOW TO SPECIFY AND ORDER



# AP422G-8478-4-P.630

Mounting Type	
E	• Thru-Bolt & Finish Washer
G	• Back-to-Back: Threaded Shoulder Bolt & Set Screws
* J	• Concealed: Threaded Shoulder Bolt & Set Screws
L	• Back-to-Back Concealed: Spanner Turning Washer & Stud
* M	• Concealed: Spanner Turning Washer & Stud
N	• Thru-Bolt with Flow-Thru Button

Door Thickness	
0	• Custom
** 1	• 3/8" **
** 2	• 1/2" **
3	• 1-3/8"
4	• 1-3/4"
5	• 2"
6	• 2-1/4"
7	• 2-1/2"
8	• 3"

Finish	
605	• Polished Brass
606	• Satin Brass
609	• Antique Brass
612	• Satin Bronze
613	• Oil Rubbed Bronze
622	• Matte Black
628	• Satin Anodized Aluminum
629	• Polished Stainless Steel
630	• Satin Stainless Steel
710	• Healthy Hardware, Satin

Optional Mid-Post	
P	• Mid-Post

Recommended for Pulls > 84" OA

Family	Description
<b>AP410: 1" Diameter</b>	
AP411	1" Diameter, Straight Standoffs, Square Ends
AP412	1" Diameter, Straight Standoffs, Radius Ends
AP413	1" Diameter, Offset Standoffs, Square Ends
AP414	1" Diameter, Offset Standoffs, Radius Ends
<b>AP420: 1-1/4" Diameter</b>	
AP421	1-1/4" Diameter, Straight Standoffs, Square Ends
AP422	1-1/4" Diameter, Straight Standoffs, Radius Ends
AP423	1-1/4" Diameter, Offset Standoffs, Square Ends
AP424	1-1/4" Diameter, Offset Standoffs, Radius Ends
<b>AP430: 1-1/2" Diameter</b>	
AP431	1-1/2" Diameter, Straight Standoffs, Square Ends
AP432	1-1/2" Diameter, Straight Standoffs, Radius Ends
AP433	1-1/2" Diameter, Offset Standoffs, Square Ends
AP434	1-1/2" Diameter, Offset Standoffs, Radius Ends

Size OA/CTC			
Overall		CTC	
12	• 12"	8	• 8"
18	• 18"	14	• 14"
24	• 24"	18	• 18"
36	• 36"	30	• 30"
48	• 48"	42	• 42"
60	• 60"	54	• 54"
72	• 72"	66	• 66"
84	• 84"	78	• 78"
96	• 96"	90	• 90"

Or Specify OA/CTC

# AP500 SERIES ANODIZED GRIP LADDER PULLS



Trimco's AP500 Series Anodized Grip Ladder Pulls add style and sophistication to any opening. A multitude of options enable flexible customization to enhance surrounding building aesthetics. Options include square or radius ends, offset or straight posts and overall lengths from 12" up to 60".

- Ends and posts are manufactured from stainless steel, bronze, brass for long-lasting durability
- Flexibility in design from straight or offset pulls to square or radius ends.
- Wide range of lengths available from 12" to 60"
- Durable and aesthetically appealing black anodized finished grip
- Multiple mounting options for metal, wood and glass doors
- Standard CTC (based on OA): Shorter than 24" is OA less 4" and greater than 24" OA less 6"
- Specifying Pull Sizes (CTC)
  - Example 1 - 35" OA, 29" CTC, specify as 3529
  - Example 2 - 11" OA, 7" CTC, specify as 1107
- For additional detail on Mounting options and kits, see "Mounting Methods" on page 3 of this catalog
- \* For J & M mounting options, specify Riv-Nut for metal doors or bushing for wood doors if required
- \*\* Glass Door mounting options for 3/8" & 1/2" door thicknesses require a W-Mount hardware kit



AP500 Series  
Anodized Grip Ladder Pull

# AP500 SERIES

## HOW TO SPECIFY AND ORDER



# AP512L-6090-4.630

Finish	
605	• Polished Brass
606	• Satin Brass
609	• Antique Brass
612	• Satin Bronze
613	• Oil Rubbed Bronze
622	• Matte Black
628	• Satin Anodized Aluminum
629	• Polished Stainless Steel
630	• Satin Stainless Steel

Mounting Type	
E	• Thru-Bolt & Finish Washer
G	• Back-to-Back: Threaded Shoulder Bolt & Set Screws
* J	• Concealed: Threaded Shoulder Bolt & Set Screws
L	• Back-to-Back Concealed: Spanner Turning Washer & Stud
* M	• Concealed: Spanner Turning Washer & Stud
N	• Thru-Bolt with Flow-Thru Button

Door Thickness	
0	• Custom
** 1	• 3/8" **
** 2	• 1/2" **
3	• 1-3/8"
4	• 1-3/4"
5	• 2"
6	• 2-1/4"
7	• 2-1/2"
8	• 3"

Family	Description
<b>AP510: 1" Diameter</b>	
AP511	1" Diameter, Straight Standoffs, Square Ends
AP512	1" Diameter, Straight Standoffs, Radius Ends
AP513	1" Diameter, Offset Standoffs, Square Ends
AP514	1" Diameter, Offset Standoffs, Radius Ends
<b>AP520: 1-1/4" Diameter</b>	
AP521	1-1/4" Diameter, Straight Standoffs, Square Ends
AP522	1-1/4" Diameter, Straight Standoffs, Radius Ends
AP523	1-1/4" Diameter, Offset Standoffs, Square Ends
AP524	1-1/4" Diameter, Offset Standoffs, Radius Ends
<b>AP530: 1-1/2" Diameter</b>	
AP531	1-1/2" Diameter, Straight Standoffs, Square Ends
AP532	1-1/2" Diameter, Straight Standoffs, Radius Ends
AP533	1-1/2" Diameter, Offset Standoffs, Square Ends
AP534	1-1/2" Diameter, Offset Standoffs, Radius Ends

Size OA/CTC			
Overall		CTC	
12	• 12"	8	• 8"
14	• 14"	10	• 10"
16	• 16"	12	• 12"
18	• 18"	14	• 14"
24	• 24"	18	• 18"
36	• 36"	30	• 30"
48	• 48"	42	• 42"
60	• 60"	54	• 54"

Or Specify OA/CTC

# AP600 SERIES

## LEATHER WRAPPED LADDER PULLS



Trimco's hand-crafted AP600 Leather Wrapped Ladder Pulls add style and sophistication to any interior. A multitude of options enable customization flexibility to enhance surrounding building aesthetics. Options include square or radius ends, offset or straight posts with center-to-center dimensions from 12" to beyond 9'. Manufactured from stainless steel, bronze, brass or aluminum and offered in most architectural finishes.

- Hand-crafted, durable leather wrap suitable for interior applications
  - Manufactured from stainless steel, bronze, brass or aluminum for long-lasting durability
  - Flexibility in design from straight or offset pulls to square or radius ends
  - Wide range of lengths available from 12" to over 9'
  - Available in most architectural finishes
  - Multiple Mounting options for metal, wood and glass doors
- 
- Standard CTC (based on OA): Shorter than 24" is OA less 4" and greater than 24" OA less 6"
  - Specifying Custom Pull Sizes (CTC) -
    - Example 1 - 35" OA, 29" CTC, specify as 3529
    - Example 2 - 11" OA, 7" CTC, specify as 1107
  - The maximum length for leather option is 96" OA
  - Leather wrap coverage ends 0.5" +/- 0.25" from the edge of both stand-offs
  - \* For J & M mounting option, specify Riv-nut for metal doors or bushings for wood doors if required
  - \*\* Glass door mounting options for 3/8" & 1/2" door thicknesses require W-Mount hardware kit



AP600 Series  
Leather Wrapped  
Ladder Pulls

# AP600 SERIES

## HOW TO SPECIFY AND ORDER



# AP622E-9690-4-B.630

Finish	
605	• Polished Brass
606	• Satin Brass
609	• Antique Brass
612	• Satin Bronze
613	• Oil Rubbed Bronze
622	• Matte Black
628	• Satin Anodized Aluminum
629	• Polished Stainless Steel
630	• Satin Stainless Steel

Mounting Type	
E	• Thru-Bolt & Finish Washer
G	• Back-to-Back: Threaded Shoulder Bolt & Set Screws
* J	• Concealed: Threaded Shoulder Bolt & Set Screws
L	• Back-to-Back Concealed: Spanner Turning Washer & Stud
* M	• Concealed: Spanner Turning Washer & Stud
N	• Thru-Bolt with Flow-Thru Button

Leather Options	
B	• Black
D	• Dark Brown
L	• Light Brown

Family	Description
<b>AP610: 1" Diameter</b>	
AP611	1" Diameter, Straight Standoffs, Square Ends
AP612	1" Diameter, Straight Standoffs, Radius Ends
AP613	1" Diameter, Offset Standoffs, Square Ends
AP614	1" Diameter, Offset Standoffs, Radius Ends
<b>AP620: 1-1/4" Diameter</b>	
AP621	1-1/4" Diameter, Straight Standoffs, Square Ends
AP622	1-1/4" Diameter, Straight Standoffs, Radius Ends
AP623	1-1/4" Diameter, Offset Standoffs, Square Ends
AP624	1-1/4" Diameter, Offset Standoffs, Radius Ends
<b>AP630: 1-1/2" Diameter</b>	
AP631	1-1/2" Diameter, Straight Standoffs, Square Ends
AP632	1-1/2" Diameter, Straight Standoffs, Radius Ends
AP633	1-1/2" Diameter, Offset Standoffs, Square Ends
AP634	1-1/2" Diameter, Offset Standoffs, Radius Ends

Door Thickness	
0	• Custom
** 1	• 3/8" **
** 2	• 1/2" **
3	• 1-3/8"
4	• 1-3/4"
5	• 2"
6	• 2-1/4"
7	• 2-1/2"
8	• 3"

Size OA/CTC			
Overall		CTC	
12	• 12"	8	• 8"
14	• 14"	10	• 10"
16	• 16"	12	• 12"
18	• 18"	14	• 14"
24	• 24"	18	• 18"
36	• 36"	30	• 30"
48	• 48"	42	• 42"
60	• 60"	54	• 54"
72	• 72"	66	• 66"
84	• 84"	78	• 78"
96	• 96"	90	• 90"

Or Specify OA/CTC

# AP700 SERIES SQUARE & RECTANGULAR LADDER PULLS

Trimco's AP700 Series Square & Rectangular Ladder Pulls are precision crafted for beauty and ultimate durability. Offered with a multitude of material sizes, these pulls can be the architectural highlight of your design.

- Manufactured from stainless steel, bronze, brass or aluminum for long lasting durability
- Flexibility in design from material sizes and orientation to standoff locations (end or bridge)
- Wide range of lengths available from 12" to over 96".
- Additional options for door thickness, leather wrapping and engraving
- Available in most architectural finishes.
- Multiple mounting methods for metal, wood and glass doors
- Standard CTC (based on OA) for bridge mount: Shorter than 24" is OA less 4" and greater than 24" OA less 6".
- Engraving includes standard black infill
- Specifying Custom Pull Sizes (CTC) for bridge mount –
- Example 1 • 35" OA, 29" CTC, specify as 3529
- Example 2 • 11" OA, 7" CTC, specify as 1107
- The maximum length for leather option is 96" OA.
- Leather is a natural product from animal hides and therefore differs from hide to hide. Variations in the texture of the leather should not be considered a fault but inherent of the natural beauty and uniqueness of the leather.
- Leather wrap coverage ends 0.5" +/- 0.25" from the edge of both stand-offs
- \* For J & M mounting option, specify Riv-Nut for metal doors or bushings for wood doors if required
- \*\* Glass Door Mounting options for 3/8" & 1/2" door thicknesses require a W-Mount hardware kit
- † Finishes with mechanical Assembly (non-welded) and includes architectural groove



AP700  
RECTANGULAR PULL  
BRIDGE POSTS

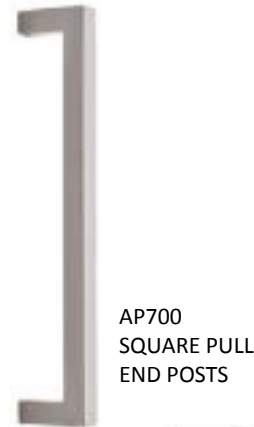

AP700  
SQUARE PULL  
END POSTS



AP700  
RECTANGULAR PULL  
END POSTS

# AP700 SERIES

## HOW TO SPECIFY AND ORDER

# AP731E-6054-4-V.630

Mounting Type	
E	• Thru-Bolt & Finish Washer
G	• Back-to-Back: Threaded Shoulder Bolt & Set Screws
* J	• Concealed: Threaded Shoulder Bolt & Set Screws

Finish	
† 605	• Polished Brass
† 606	• Satin Brass
† 609	• Antique Brass
† 612	• Satin Bronze
† 613	• Oil Rubbed Bronze
622	• Matte Black
† 628	• Satin Anodized Aluminum
629	• Polished Stainless Steel
630	• Satin Stainless Steel

Door Thickness	
0	• Custom
** 1	• 3/8"
** 2	• 1/2"
3	• 1-3/8"
4	• 1-3/4"
5	• 2"
6	• 2-1/4"
7	• 2-1/2"
8	• 3"

Options	
<b>Leather</b>	
B	• Leather - Black
D	• Leather - Dark Brown
L	• Leather - Light Brown
<b>Engraving</b>	
<b>Single Pull</b>	
U	• PUSH
V	• PULL
W	• Other - Customize
<b>BTB Pulls</b>	
X	• PUSH/Interior & PULL/Exterior
Y	• PULL/Interior & PUSH/Exterior
Z	• Other - Customize

Family	Description		
<b>AP710: 3/4" x 3/4" Square</b>			
	Face	Depth	
AP711	3/4"	3/4"	3/4" Square Pull, Bridge Posts
AP712	3/4"	3/4"	3/4" Square Pull, End Posts
<b>AP720: 1" x 1" Square</b>			
	Face	Depth	
AP721	1"	1"	1" Square Pull, Bridge Posts
AP722	1"	1"	1" Square Pull, End Posts
<b>AP730: 1-1/4" x 1-1/4" Square</b>			
	Face	Depth	
AP731	1-1/4"	1-1/4"	1-1/4" Square Pull, Bridge Posts
AP732	1-1/4"	1-1/4"	1-1/4" Square Pull, End Posts
<b>AP750: 1/2" x 1-1/4" Rectangular</b>			
	Face	Depth	
AP751	1/2"	1-1/4"	1/2" x 1-1/4" Rectangular Pull, Bridge Posts
AP752	1/2"	1-1/4"	1/2" x 1-1/4" Rectangular Pull, End Posts
AP753	1-1/4"	1/2"	1-1/4" x 1/2" Rectangular Pull, Bridge Posts
AP754	1-1/4"	1/2"	1-1/4" x 1/2" Rectangular Pull, End Posts
<b>AP760: 1" x 1-1/2" Rectangular</b>			
	Face	Depth	
AP761	1"	1-1/2"	1" x 1-1/2" Rectangular Pull, Bridge Posts
AP762	1"	1-1/2"	1" x 1-1/2" Rectangular Pull, End Posts
AP763	1-1/2"	1"	1-1/2" x 1" Rectangular Pull, Bridge Posts
AP764	1-1/2"	1"	1-1/2" x 1" Rectangular Pull, End Posts
<b>AP770: 1" x 2" Rectangular</b>			
	Face	Depth	
AP771	1"	2"	1" x 2" Rectangular Pull, Bridge Posts
AP772	1"	2"	1" x 2" Rectangular Pull, End Posts
AP773	2"	1"	2" x 1" Rectangular Pull, Bridge Posts
AP774	2"	1"	2" x 1" Rectangular Pull, End Posts

Size OA/CTC	
Overall	CTC
Bridge Posts Only	Required for All Pulls
12 • 12"	8 • 8"
14 • 14"	10 • 10"
16 • 16"	12 • 12"
18 • 18"	14 • 14"
24 • 24"	18 • 18"
36 • 36"	30 • 30"
48 • 48"	42 • 42"
60 • 60"	54 • 54"
Or Specify OA/CTC	

# APC20 SERIES CLOSET & CABINET PULLS

Trimco's APC20 Series are a sleek and simple modern designed pull for closet and/or cabinet door applications. They are available in 1/2", 3/4" and 1" widths standard and multiple architectural finishes to compliment any design intent. Custom widths and finishes are also available.

- Modern, architecturally inspired design.
- Manufactured from durable solid aluminum.
- Available in many anodized finishes, as well as custom color matching.
- Thru-bolted, concealed mounting or back-to-back.
- Standard widths: 1/2", 3/4" and 1". Custom widths also available.
- Standard 9" center-to-center, and 10" overall length.
- Leather wrap coverage ends 0.5" +/- 0.25" from the edge of both stand-offs.
- Leather is a natural product from animal hides and therefore differs from hide to hide. Variations in the texture of the leather should not be considered a fault but inherent of the natural beauty and uniqueness of the leather.
- \* For J & M mounting option, specify Riv-Nut for metal doors or bushings for wood doors if required.
- \*\* Glass Door Mounting options for 3/8" & 1/2" door thicknesses require a W-Mount hardware kit.



## HOW TO SPECIFY AND ORDER

# APC21E-4-L.629

Finish	
313	• Dark Bronze Anodized
335	• Black Anodized
628	• Clear Anodized - Satin
712	• Bright Anodized - Polished

Options	
Leather	
B	• Leather - Black
D	• Leather - Dark Brown
L	• Leather - Light Brown

Mounting Type	
E	• Thru-Bolt & Finish Washer
G	• Back-to-Back: Threaded Shoulder Bolt & Set Screws
* J	• Concealed: Threaded Shoulder Bolt & Set Screws

Door Thickness	
0	• Custom
** 1	• 3/8"
** 2	• 1/2"
3	• 1-3/8"
4	• 1-3/4"
5	• 2"
6	• 2-1/4"
7	• 2-1/2"
8	• 3"

Family	Description		
<b>APC20: Rectangular Pull</b>			
	Width	Depth	
APC21	1/2"	1/2"	1/2" x 1/2" Square Pull, 9" CTC
APC22	3/4"	1/2"	3/4" x 1/2" Rectangular Pull, 9" CTC
APC23	1"	1/2"	1" x 1/2" Rectangular Pull, 9" CTC

# APC30 SERIES

## MODERN EDGE PULL

Trimco's APC30 Series are a sleek and simple modern designed pull for closet and/or cabinet door applications. They are available in multiple standard lengths and architectural finishes to compliment any design intent. Custom lengths and finishes are also available.

- Modern, architecturally inspired design
- Manufactured from durable solid aluminum
- Available in many anodized finishes, as well as custom color matching
- Thru-bolted, concealed mounting or back-to-back
- Standard lengths from 3" to 24". Custom lengths also available
- Standard for 1-3/8" and 1-3/4" doors. Can also be used for thicker doors



APC31  
 3" Long  
 Modern  
 Edge Pull

## HOW TO SPECIFY AND ORDER

# APC31.628

Finish	
313	• Dark Bronze Anodized
335	• Black Anodized
628	• Clear Anodized - Satin
712	• Bright Anodized - Polished

Family	Description		
<b>APC30: Edge Pull</b>			
	Width	Length	
APC31	2-1/2"	3"	Edge Pull, 3" Length
APC32	2-1/2"	4"	Edge Pull, 4" Length
APC33	2-1/2"	6"	Edge Pull, 6" Length
APC34	2-1/2"	8"	Edge Pull, 8" Length
APC35	2-1/2"	10"	Edge Pull, 10" Length
APC36	2-1/2"	12"	Edge Pull, 12" Length
APC37	2-1/2"	18"	Edge Pull, 18" Length
APC38	2-1/2"	24"	Edge Pull, 24" Length

# WS SERIES

## BARN DOOR WALL STRIKE

Trimco's patented Wall Strikes are uniquely designed as a solution for latching surface applied sliding/barn doors. For use with Trimco's 1074 Series ADA locks. The strike mounts to the wall either directly (requires blocking in wall) or via a mounting bracket that mounts to the jamb. Available in most architectural finishes to match the other hardware or with a primer finish that can be painted to match the wall color.

- Designed for use with the Trimco's 1074 Series ADA barn/sliding Latchsets.
- Vertical adjustability ensures proper latching as the building or door opening settles.
- Concealed fasteners for sleek, modern appearance.
- Available in most architectural finishes, or primer to match the wall paint color.
- Enables latching of surface sliding/barn doors.
- Two mounting methods: Direct to wall (Requires blocking in the wall) or via Mounting Bracket.



WS



WSJ

## HOW TO SPECIFY AND ORDER

# WS-1074-2.622

Family	Description
<b>WS: WALL STRIKES</b>	
WS	Wall Strike - Direct Mount
WSJ	Wall Strike - Jamb Mount

Mating Lock	
1074-1	• Tubular (1074-1 or 1074-3)
1074-2	• Mortise

Finish	
605	• Polished Brass
606	• Satin Brass
613	• Oil Rubbed Bronze
622	• Matte Black Powder Coat
625	• Polished Chrome
626	• Satin Chrome
600W	• White Prime Coat

# 1074 SERIES

## ADA BARN DOOR HARDWARE

The Trimco 1074 Series Barn & Pocket Door Latchsets deliver a unique solution for sliding door applications. With 10 modern lever styles available, the 1074 Series is an ideal solution for offices and multifamily projects where high design is important. These latchsets are offered with either tubular or mortise locks for medium to high use situations. The 1074 Series is ADA compliant for use in public facilities.

- Unique barn and sliding door locking solution
- Can be used with Trimco Wall Strike for locking of surface applied barn doors
- ADA compliant
- Multiple functions for different applications
- Ten different lever styles to choose from
- Only requires 10 degrees of rotation to unlatch
- 1074-1 Privacy function has a push button on the inside and emergency access on the outside
- 1074-2 Privacy function has a thumb turn on the inside and cylinder on the outside
- 1074-3 is Passage function with tubular latch
- Backset: 2-3/8" for tubular locks (1074-1 & 1074-3); 2-3/4" for mortise locks (1074-2)
- Door Thickness: 1-3/8" & 1-3/4" for tubular locks (1074-1 & 1074-3); 1-3/4" for mortise locks (1074-2)
- 1074-2 includes mortise type cylinder and cam
- All units include their own strike



1074-1



1074-2

# 1074 SERIES

## HOW TO SPECIFY AND ORDER

# 1074-1-LH-ST001.630

Finish	
622	• Matte Black
629	• Polished Stainless Steel
630	• Satin Stainless Steel
Other finish options available. Contact Customer Service.	

Handing	
LH	• Left Hand
RH	• Right Hand

Lever Style	
ST000	• *Stockholm
ST001	• *Munich
ST002	• *Frankfurt
ST003	• Koln
ST028	• Vienna
ST037	• Matisse
SC001	• Bellini
SC037	• Glen Ellen
SC051	• *Merryvale
SC069	• Mahler
* Stock Lever Style	

Family	Description
<b>1074: ADA BARN/SLIDING DOOR HARDWARE</b>	
1074-1	Tubular Privacy
1074-2	Mortise Sectional Privacy
1074-2x5004	Mortise Sectional Privacy with Occupancy Indicator
1074-2C	Mortise Sectional Constant Latching
1074-2E	Mortise Escutcheon Privacy
1074-2Ex5004	Mortise Escutcheon Privacy with Occupancy Indicator
1074-3	Tubular Passage

# 1069 SERIES

## ADA POCKET DOOR PULLS

The Trimco 1069 Series pocket door pulls are uniquely designed to meet American with Disabilities Act (ADA) requirements for pocket door applications. With a contemporary design and stylish, black nylon handles the 1069 Series is built for the most demanding applications while remaining aesthetically pleasing. The 1069 Series is available in multiple functions and is fully customizable for most pocket door applications.

- Complete ADA pocket door solution.
- Stylish, black nylon handles standard.
- Easy installation and operation. Operates with heel, edge of hand or with the arm.
- Multiple functions for different applications.
- 5-1/2" Standard frame width; other frame width options available.
- Can be used on a 1-3/8" door; as well as a 1-3/4" door.
- Multiple functions for different applications.
- Exterior emergency access of full privacy.
- \* Handing specification is for FP models only.
- Offset 1069 configurations are available - contact customer service.
- Frame size: products will be made to the wide dimension of the range as standard (i.e. for "B" with range of 5-3/4" to 7", 1069 will be manufactured for 7" frame). Advise if special dimension is required.



1069



1069L



1069FP

# 1069 SERIES

## HOW TO SPECIFY AND ORDER



# 1069FP-A-RH-4.630

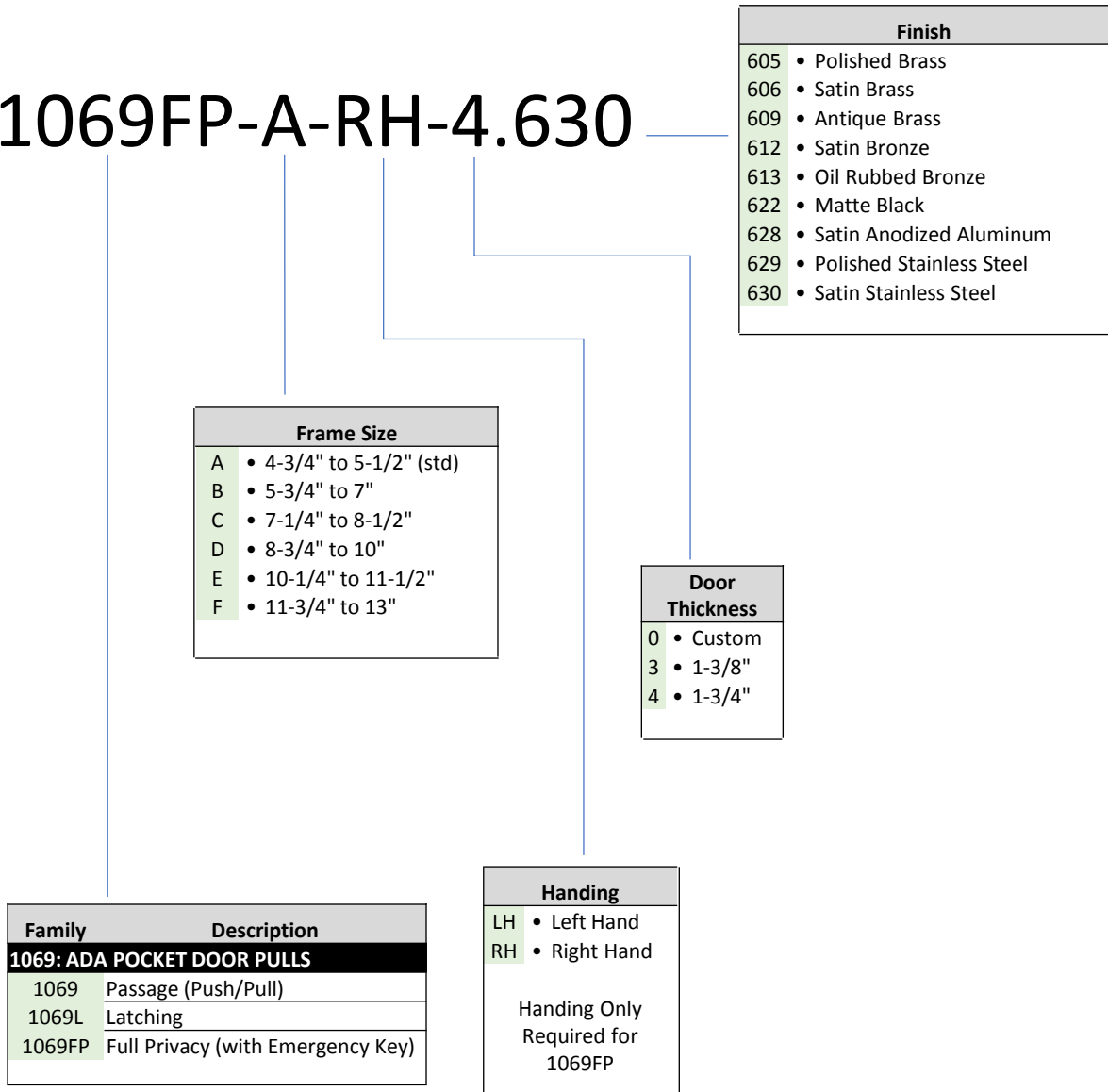

Family	Description
<b>1069: ADA POCKET DOOR PULLS</b>	
1069	Passage (Push/Pull)
1069L	Latching
1069FP	Full Privacy (with Emergency Key)

Frame Size
A • 4-3/4" to 5-1/2" (std)
B • 5-3/4" to 7"
C • 7-1/4" to 8-1/2"
D • 8-3/4" to 10"
E • 10-1/4" to 11-1/2"
F • 11-3/4" to 13"

Door Thickness
0 • Custom
3 • 1-3/8"
4 • 1-3/4"

Handing	
LH • Left Hand	
RH • Right Hand	
Handing Only Required for 1069FP	

Finish
605 • Polished Brass
606 • Satin Brass
609 • Antique Brass
612 • Satin Bronze
613 • Oil Rubbed Bronze
622 • Matte Black
628 • Satin Anodized Aluminum
629 • Polished Stainless Steel
630 • Satin Stainless Steel

# MODERN MASTERPIECES

For over 65 years, Trimco has been designing and manufacturing exquisite, hand crafted door pulls. Available in solid brass, and bronze in an array of flawless finishes; this distinctive line of superior door pulls is meticulously engineered and fabricated to provide a long product life and lasting beauty.



<b>TRIMCO# 1301</b>	
<b>Door Pull – Cast</b>	
OA	10-1/2"
CTC	9"
Offset	2"



<b>TRIMCO# 1310</b>	
<b>Door Pull – Cast</b>	
CTC	12"
OFF	7"
CL	1-5/8"
D	15"

ADA



<b>TRIMCO# 1320</b>	
<b>Door Pull – Cast</b>	
OA	9"
OFF	5-1/2"
P	1-7/8"
CTC	7"
CL	1-1/2"

ADA



<b>TRIMCO# 1330</b>	
<b>Door Pull – Cast</b>	
H	13-1/2"
P	2-11/16"
OFF	7-5/8"
CTC	11"

ADA



<b>TRIMCO# 1340</b>	
<b>Door Pull – Cast</b>	
L	23-1/4"
P	2-1/2"
OFF	5-1/4"
CTC	21
CL	1-1/2"

ADA

L= Length, P= Projection, OFF= Offset, CTC= Center to Center, W=Width, CL= Clearance

# MODERN MASTERPIECES



**TRIMCO# 1350L / 1358R**

H	12"
W	2-1/2"
P	5-1/4"
CTC	9"
CL	3-5/8"

**Door Pull – Cast**

ADA



**TRIMCO# 1360**

D	6"
OFF	3"
P	2"
CTC	4-3/4"
CL	1-1/2"

**Door Pull – Cast**

ADA



**TRIMCO# 1370**

D	9"
P	4-1/2"
W	2"
CTC	8"

**Door Pull – Cast**



**TRIMCO# 1380**

OA	5"
P	2"
CTC	4 x 2-3/4"
CL	1-11/16"

**Door Pull – Cast**

ADA

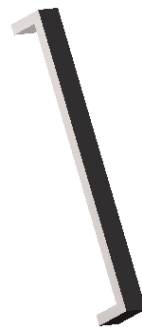

**TRIMCO# 1410      1410-1**

L	23-3/4"	18"
W	2"	2"
P	2-1/2"	2-1/2"
CTC	22-3/4"	17"

**Door Pull – Cast**

ADA

L= Length, P= Projection, OFF= Offset, CTC= Center to Center, W= Width

# CLASSIC PUSH, PULLS & GRIPS

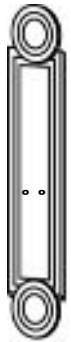

**TRIMCO# 15 / STANLEY**  
 OA 3/4 x 3-1/2 x 20-1/2"  
**Classic Push Plate – Cast**  
 Solid Brass or Bronze gives rich, old-world feeling. Rough textured interior on decorative plate.  
 Br, Bz, Pl  
 (Stanley = Mastercraft Bronze Line)



**TRIMCO# 16 / PIERCE**  
 OA 3/4 x 3-1/2 x 20-1/2"  
 G 1117-1  
 P 2-1/8"  
 CL 1-1/2"  
 CTC 5"  
 Br, Bz, Pl  
**Classic Pull Plate – Cast** Alternate grip style available. Rough textured interior on decorative plate.  
 (Pierce = Mastercraft Bronze Line)

ADA



**TRIMCO# 17 / LAVA**  
 OA 7/16 x 3-5/8 x 20-1/2"  
 Br, Bz, Pl  
**Classic Push Plate – Cast**  
 Solid Brass or Bronze. Classic Church Gothic. Rough textured interior on decorative plate.  
 (Lava = Mastercraft Bronze Line)



**TRIMCO# 18 / LAVA-CAIRO**  
 OA 7/16 x 3-5/8 x 20-1/2"  
 G 1183-1  
 P 2-1/2"  
 CL 1-1/2"  
 CTC 5"  
 Br, Bz, Pl  
**Classic Pull Plate – Cast** Alternate grip styles available. Rough textured interior on decorative plate.  
 (Lava-Cairo = Mastercraft Bronze)

ADA



**TRIMCO# 35**  
 OA 17-3/8"  
 B 2-3/4"  
 P 4-1/2"  
 CL 2-1/4"  
 CTC 12-1/2"  
 Br, Bz, Pl  
**Classic Door Pull – Cast**

ADA



**TRIMCO# 50 / WENDELL**  
 OA 3/8 x 3-3/4 x 15"  
 Br, Bz, Pl  
**Classic Push Plate – Cast** Timeless Elegant Style. Rough textured interior on decorative plate.  
 (Wendell = Mastercraft Bronze Line)



**TRIMCO# 51 / WENDELL X 1117-1**  
 OA 3/8 x 3-3/4 x 15"  
 G 1117-1  
 P 2-1/4"  
 CL 1-1/2"  
 CTC 5"  
 Br, Bz, Pl  
**Classic Pull Plate – Cast** Alternate grip styles available. Rough textured interior on decorative plate.  
 (Wendell x 1117-1 = Mastercraft Bronze Line)

ADA



**TRIMCO# 57**  
 OA 9-3/4"  
 B 1-3/4"  
 P 2-5/8"  
 CL 1-1/2"  
 CTC 8"  
 Br, Bz, Pl  
**Classic Grip – Cast** With 1-3/4" dia. Roses. Timeless Elegance. Can be mounted on a variety of plates.  
 Standard Mountings - See page 3

ADA

**Note:** Dimpled finish on decorative plate. Rough textured interior on decorative plate.

B = Base, CL = Clearance, CTC = Center to center, G = Grip, OA = Overall size, P = Projection

# CLASSIC PRODUCTS

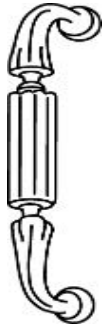

TRIMCO#	58	59
OA	9"	10-15/16"
B	15/16"	15/16"
P	2-1/2"	2-1/2"
CL	1-1/2"	1-1/2"
CTC	8"	10"

Br, Bz

**Classic Grip – Cast**  
Available with roses.  
Specify when ordering.

ADA



TRIMCO#	111
OD	3-5/8"
ID	2-3/16"

Br, Bz, Pl

**Classic Escutcheon**  
Stamped ring.

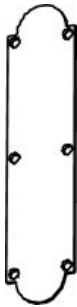

TRIMCO#	1070-2
OA	3-1/2 x 15"

Br, Bz

**Classic Push Plate**  
.050 Solid Brass or  
Bronze Plate tasteful,  
refined style.



TRIMCO#	1071-2
OA	3-1/2 x 15"
P	2-1/2"
G	#58
CL	1-1/2"
CTC	8"

Br, Bz

**Classic Pull Plate**  
.050 Solid brass or bronze Plate.

ADA



TRIMCO#	Aberdene X Velazquez
QA	3-1/2 x 14-3/4"
G	1136-1
P	2-1/4"
CL	1-1/2"
CTC	6-1/4"

Br, Bz, Pl

**Classic Pull Plate – 3/16" thick**  
Solid brass or bronze.  
Formerly : 1900 Pull Plate

ADA



TRIMCO#	Aberdene
OA	3-1/2"x14-3/4"

Br, Bz, Pl

**Classic Push Plate – 3/16" thick**  
Solid brass or bronze, gives solid,  
high achiever feeling.  
Formerly : 1901 Push Plate

CL= Clearance, CTC= Center-to-center, G= Grip, OA= Overall size,  
P= Projection, ID= Inside Diameter

# fOCAL PRODUCTS

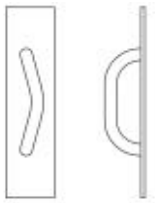

TRIMCO#	7180	7181
D	3/4"	3/4"
CTC	6"	8"
P	2-1/4"	2-1/4"

**fOCAL Interior Wing Pull**  
 3 x 12" plain backplate standard  
 thru-bolt mounting standard  
 .S - 1" dia. Black style plate (no  
 BP) thru-bolt mounting  
 standard



TRIMCO#	7191
D	1"
CTC	10"
P	2-1/2"

**fOCAL Offset Door Pull**  
 Black style plate  
 standard



TRIMCO#	7196-1	7196-2	7196-3
CTC	8"	10"	12"

**fOCAL Cool Touch Pull with PVC**  
 Changes the ambient by 20  
 degrees.  
 BTB available

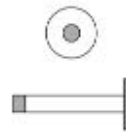

TRIMCO#	7208
D	1/2"
L	3-1/2"
PL	1-1/2" dia.

**fOCAL Pencil Stop**  
 Hanger bolt standard for wood.  
 Specify if mounting to metal.



TRIMCO#	7276	W7276
D	2-3/16"	2-3/16"
H	1"	1"

**fOCAL Wall Bumper**  
 Toggler standard  
 Concave (V) shown  
 Convex (X) available



TRIMCO#	7278
OD	1-1/2"
P	1" dia.

**fOCAL Décor Wall Stop**  
 Concave - Black Rubber  
 Wood screw & plastic toggle standard.



TRIMCO#	7280	7281
D	1-1/4"	1-3/4"
H	1-9/16"	2-1/4"

**fOCAL Floor Stop**  
 MS & Anchor  
 Standard. Specify for  
 wood floor.



TRIMCO#	7285
D	1-3/4"
H	2-1/4"

**fOCAL Stop with Bail & Hook**  
 Specify for wood floor.

B= Base, CL= Clearance, CTC = Center to center, OA = Overall size,  
 P= Projection, D= Diameter, H= Height, L= Long

# FOCAL PRODUCTS



TRIMCO#	7001	7009
H	16"	16"
W	4"	6"

### fOCAL Push Plate

No screw holes standard. Adhesive mounting standard.

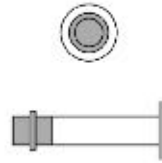

### TRIMCO# 7010

D	5/8"
L	3-3/8"
PL	1-1/4" dia.

### fOCAL Robe Hook & Stop

Hanger bolt standard for wood. Specify if mounting to metal.

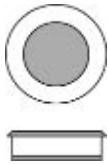

### TRIMCO# 7059

D	2-1/2"
---	--------

### fOCAL Flush Pull Black

interior standard  
Standard prep 2-1/8" dia. Fits BTB in a 1-3/8" door.

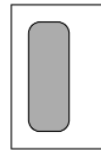

### TRIMCO# 7060 7061

H	4-1/4"	3-1/8"
W	2-3/4"	2-1/16"

### fOCAL Flush Pull Black

interior standard.  
Specify if the interior finish is to match face plate.



### TRIMCO# 7140 7141

D	3/4"	3/4"
CTC	6"	8"
P	2-1/4"	2-1/4"

### fOCAL Interior D-Pull

3 x 12" backplate standard  
thru-bolt mounting standard  
.S – 1" dia. Black style plates (no BP) thru-bolt mounting standard

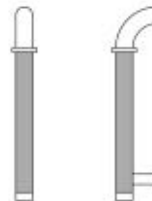

### TRIMCO# 7150

D	1"
CTC	10"
P	2-1/2"
OA	11-3/4"

### fOCAL Cane Pull

Matte Black Poly Grip

ADA

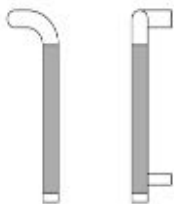

### TRIMCO# 7160

D	1"
CTC	10"
P	2-1/2"
L	11-3/4"
OFF	2-3/4"

### fOCAL Offset Cane Pull

Matte Black Poly Grip  
Standard Specify hand  
BTB available

ADA



### TRIMCO# 7170

D	1"
CTC	10"
P	2-1/2"

### fOCAL Entry Wing Pull

Black style plates standard

ADA

D= Diameter, CTC= Center-to-center, H= Height, W= Width, P= Projection

# LOCKDOWN HARDWARE



**TRIMCO#** LDH100-PHI

**LOCKDOWN HARDWARE - PRECISION**

Apex 2000 Series



**TRIMCO#** LDH100-VD

**LOCKDOWN HARDWARE- VON  
DUPRIN**

For use with 98/99 and 33/35 Series  
devices.

**TRIMCO#** LDH100-VD-48

**Kit for 48" VD Devices**

Includes replacement tube and  
cotter pin.

**TRIMCO#** LDH100-VD-97

**Cam Replacement Kit: Pre-1997  
Devices**

Includes replacement cam and  
cotter pin.

**TRIMCO#** MLDHVD00013

**Replacement End Cap Bracket for  
VD Devices**

Available for older Von Duprin  
Devices that are currently installed  
with the 3-screw end cap.



**TRIMCO#** LDH100-DM

**LOCKDOWN HARDWARE - DORMA**

For use with 9000 Series devices.

**TRIMCO#** LDH100-DM-48-TUBE

**Kit for 48" Dorma Devices**

Includes replacement tube

#### FEATURES:

- Simple one-touch mechanical lockdown for exit devices
- Cost-effective, aftermarket or new construction solution
- Does not require a key or hex-wrench to lock down doors
- Durable die-cast construction
- ADA Compliant
- Easy installation requires no special tools or removal of the panic device from the door
- Works with hex or cylinder dogging devices

#### FUTURE AVAILABILITY:

- MK - Marks M9900

# BOLTS

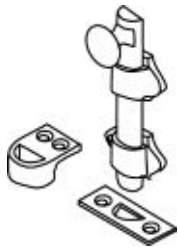

TRIMCO#	3920-4	3920-8
OA	4-1/4"	8"
TH	1/2" - 1"	1" - 2"

Br, Bz, Pl

**Dutch Door Bolt – Cast**  
 Cast Strike for application without shelf and Flat Mortise Strike supplied.  
 Other lengths available.  
**(3920-8)** Universal Strike supplied. Please specify angle or mortise strike.

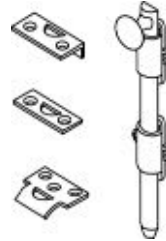

**TRIMCO# 3921**  
**Heavy - duty Surface Bolt**  
 Available in 8", 12", 18", 24".  
 Please specify length and universal, angle or mortise strike.  
 Custom lengths available.



TRIMCO#	3922	3923
OA	2" x 8"	2" x 12"
TH	1-1/8"	1-1/8"
P	1-5/16"	1-5/16"
M	Steel 3/4" x 1/4"	Steel 3/4" x 1/4"
BHMA	L04161	L04161

**Heavy - duty Surface Bolt**  
 Available in Stainless Steel. Furnished with Surface and Mortise Strikes.  
 Custom lengths available.

Br, Bz, Pl, SS



**TRIMCO# 3922L**  
**Locking Heavy - duty Surface Bolt**  
 Accepts padlock (furnished by buyer) furnish with surface and Mortise strike with torx screws for security. Custom lengths made to order upon request.



**TRIMCO# 3922NYPV**  
**Prison Version Heavy - duty Surface Bolt**  
 Includes torx screws along with additional spring and holding power designed specifically for abusive environments like cell doors.



M = Material, CTC = Center to center, TH = Thickness, OA= Overall Size, P = Projection

# BOLTS & GUIDES

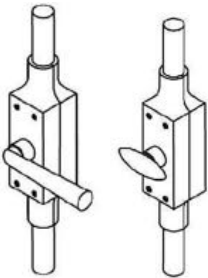

TRIMCO#	3928K	3928L
OA	1-9/16" X 6-13/16"	1-9/16" X 6-13/16"
	up to 90" rod	up to 90" rod
ROD	5/8", half round	5/8", half round

Br, Bz, Pl

### Cremone Bolt - Cast

Decorative Bolt for pairs of doors. Mortise and surface strikes included. "K" supplied with oval knob. "L" supplied with lever operator. Specify height and door handing.

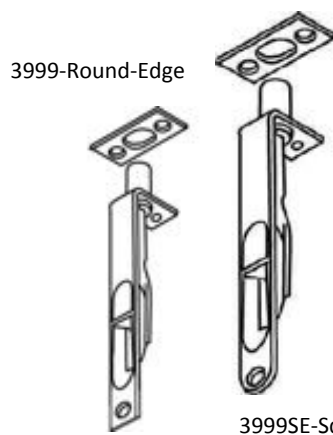

TRIMCO#	3999SE
OA	3/4" x 6"
TH	1"
D	1/2" Bolt
BHMA	L04201

Br, Bz, Pl

### Flushbolt - 6"

Corner Mount for unlisted wood doors. Add "SE" for Square edges.

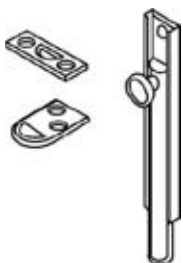

TRIMCO#	4873	4874	4876	4882
L	3"	4"	6"	12"
W	5/8"	5/8"	5/8"	5/8"
TH	5/8"	7/8"	1"	2-1/4"
BHMA	L04151	L04151	L04151	L04151
	Surface Bolt 3	Surface Bolt 4	Surface Bolt 6	Surface Bolt 12

Universal and Mortise Strikes supplied. Custom lengths available.

D = Diameter, L = Length, M = Material, OA = Overall size, TH = Throw, W = Width

# BOLTS & LATCHES

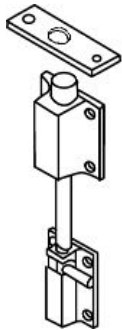

<b>TRIMCO#</b>	<b>243T</b>
OA	3/8" x 15"
M	Brass/Bronze
TH	1-1/2"

Br, Bz, Pl

**Cane Bolt Top - Cast**  
 Decorative Bolts for pairs of doors. Top door bolt with surface and mortise strikes included.

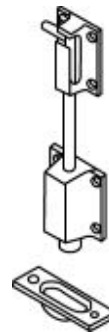

<b>TRIMCO#</b>	<b>244B</b>
OA	3/8" x 30"
M	Brass/Bronze
TH	1-1/2"

Br, Bz, Pl

**Can Bolt Bottom - Cast**  
 Decorative Bolts for pairs of doors. Bottom door bolt with cup strike included.

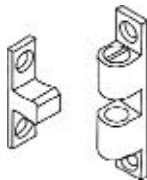

<b>TRIMCO#</b>	<b>802</b>	<b>804</b>
OA	3/8" x 1-15/16"	1/2" x 2-3/4"
M	Brass	Brass
STR	5/16" x 1-1/8"	13-32" x 1-9/16"
BHMA	B03291	B03291

**3-Way Cabinet Catch**  
 Machine Finish.



<b>TRIMCO#</b>	<b>810</b>
OA	3-1/4" x 1" x 3/4"
M	Zinc over Steel
STR	3-1/8" x 7/8" or (2) 1-1/8" x 13/16"

**Heavy - Duty Magnetic Catch**

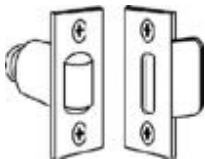

<b>TRIMCO#</b>	<b>1554</b>
OA	1-1/8" X 2-1/4"
DP	2-1/4"
BHMA	E09101

Br, Bz, Pl

**Roller Latch**  
 Fits residential latch bolt prep. Adjustable Nylon Roller  
 3 Types of Strikes available  
 "B" Strike Shown.

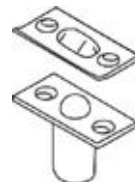

<b>TRIMCO#</b>	<b>1555</b>	<b>1555L</b>
OA	1" x 2-1/8"	1" x 2-1/8"
DP	1-3/16"	1" x 3/16"
STR	1-1/16" x 2-1/8"	1-3/8" x 2-1/8"

Br, Bz, Pl

**Closet Ball Catch**  
 Light - duty ball latch Adjustable roller force 1555 is shown.

DP = Depth, OA = Overall size

# LATCHES & STRIKES

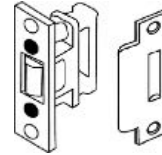
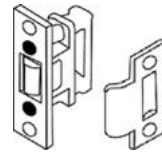
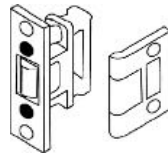

TRIMCO#	1559WA	1559WB	1559WC
OA - LATCH	1/8"1" x 3-3/8"	1/8" x 1" x 3-3/8"	1/8" X1" X 3-3/8"
OA - STRIKE	3/16" X 1-3/4" X 2-1/4"	3/32" x 2" 2-3/4"	3/32" x 2" 4-7/8"
DP - LATCH	1-13/16"	1-13/16"	1-13/16"
BHMA - LATCH	E09091	E09091	E09091

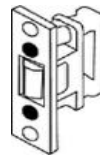
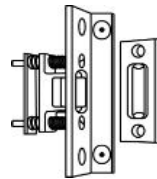

TRIMCO#	1559BL	1559
OA - LATCH	1/8" x 1-1/2" x 4-1/2"	1/8" x 1" x 3-3/8"
DP - LATCH	2-1/2"	1-13/16"
BHMA - LATCH	E09111	E09091

TRIMCO#	1559A
OA	3/16" x 1-3/4" x 2-1/4"

Strike only for Heavy - Duty Roller Latch 1559 (1559WA) Cast  
 2-1/4" Full Lip.



TRIMCO#	1559B
OA	3/32" x 2" x 2-3/4"

Strike only for Heavy - Duty Roller Latch 1559 (1559WB)  
 Br, Bz, Pl



TRIMCO#	1559C
OA	3/32" x 2" x 4-7/8"

Strike only for Heavy - Duty Roller Latch 1559 (1559WC)  
 Br, Bz, Pl

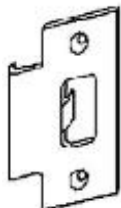

TRIMCO#	3651
OA	3/32" x 2" x 2-3/4"
BHMA	115.3

Strike - 2-3/4" Adjustable tang.  
 Br, Bz, Pl

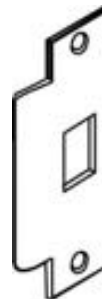

TRIMCO#	3652
OA	3/32" x 2" x 4-7/8"
BHMA	115.2

Strike Adjustable tang.  
 Br, Bz, Pl



DP = Depth, OA = Overall size

# FLUSH BOLTS & DUST PROOF STRIKES

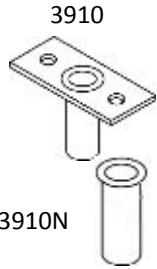

TRIMCO#	3910	3910N
OA	3/32" x 1-5/16" x 2-1/2"	
DP	1-1/2"	
BHMA	L04021	

Br, Bz, Pl, SS

### Dust Proof Strike

To omit faceplate add suffix "N". Available in Stainless steel.

3910N  
(No Face Plate)



TRIMCO#	3911
OA	3/32" x 1-5/16" x 1-5/8"
DP	1-1/2"
BHMA	L04021

Br, Bz, Pl, SS

### Adjustable Dust Proof Strike

For carpet or threshold. Available in stainless steel.



TRIMCO#	3913	W3913
OA	1" x 6-3/4" x 2-1/2"	1" x 6-3/4" x 2-1/2"
TH	3/4"	3/4"
M	Extruded	Wrought

Br, Bz, Pl

### Flush Extension Bolt - Wood Door

Includes metal dust cover. Mounts at top corner of wood door.

Patent # 4315647

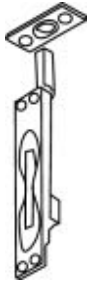

TRIMCO#	3915
OA	1-1/4" X 6-3/4"
TH	11/16"
ROD	6" - 30"
BHMA	L04081

Br, Bz, Pl

### Flush Extension Bolt

Metal Door



TRIMCO#	3916
OA	1" X 15-1/2"
TH	5/8"
BHMA	L04081

Br, Bz, Pl

### Flush Extension Bolt

One piece flushbolt for non-labeled, tall wood doors. Other lengths available.



TRIMCO#	3917	W3917	3917ET
OA	1" x 6-3/4"	1" x 6-3/4"	1" x 6-3/4"
TH	11/16"	11/16"	1-3/16"
ROD	12"	12"	12"
M	Extruded	Wrought	Extruded
BHMA	L04081/L04251	L04081/L04251	L04081



### Flush Extension Bolt

Metal Door - 1-1/2" Bolthead (3917-1B) standard; 3" Bolthead (3917-3B) also available. Longer rod lengths available on request.

Patent# 4315647

Br, Bz, Pl

M= Material, O= Overall size, DP= Depth, TH= Throw

# QUIET, LOW CLOSER FORCE AUTO FLUSHBOLTS, DUBL-BOLT



**TRIMCO# 3810**  
 BHMA 4.4 Type 25  
 Br, Bz, Pl, SS

**Automatic Flushbolt**  
 Metal Doors - To be used in pairs on the inactive leaf of metal doors.  
 UL Rated 3 hours.



**TRIMCO# 3815L**  
 BHMA 4.4 Type 25  
 Br, Bz, Pl, SS

**Automatic Flushbolt**  
 Wood Doors - To be used in pairs on the inactive leaf of wood doors.

UL Rated 1-1/2 Hours.  
**Patent #5076620**  
 Can be used with the 3825 or 3850 Firebolt.  
**3815L x 3850** UL Rated 20 Minutes on wood door.



**TRIMCO# 3820**  
 BHMA 4.4 Type 25  
 Br, Bz, Pl, SS

**Semi-Automatic Flushbolt**  
 Metal Doors - For use at top of the inactive leaf metal doors. Use with the 3810.  
 UL Rated 3 hours  
**Patent #5004277**  
 Can be used with the 3850 Firebolt.



**TRIMCO# 3825L**  
 BHMA 4.4 Type 25  
 Br, Bz, Pl, SS

**Semi-Automatic Flushbolt** Wood Doors - For use at top of the inactive leaf of wood doors. Use with the 3815L

UL Rated 1-1/2 Hours  
**Patent #5004277**  
 Can be used with the 3850 Firebolt.  
**3825L x 3850** UL Rated 20 Minutes on a wood door.

**Note:** Designed for use in pairs (top & bottom) with Trimco Door Coordinators. All Automatic and Semi-Automatic Flushbolts are supplied with Trimkits. Specify finish when ordering. All of the above can be used with TRIMCO 3850 Firebolt.

TRIMCO#	3830A	3830AL	3830M	3830WL
	<b>Finish Kit</b>	<b>Long Finish Kit</b>	<b>Finish Kit</b>	<b>Long Finish Kit</b>
	Automatic Flushbolt Metal Door	Automatic Flushbolt Wood Door	Semi-Automatic Flushbolt Metal Door	Semi-Automatic Flushbolt Wood door

Br, Bz, Pl, SS



**TRIMCO# 3850**  
 Br, Bz, Pl, SS

**Firebolt**  
 For use with the 3810, 3815L, 3820 and 3825L to replace the bottom bolt. Can also be used in conjunction with vertical rod panic devices.

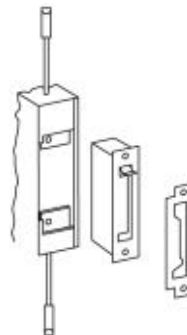

**TRIMCO# 3900**  
 Br, Bz, Pl, SS

**Dubl-Bolt**  
 Two - Point Flushbolt for inactive door of a pair of hollow metal doors.

DP = Depth, OA = Overall size, BS = Back set, STR = Strike

# DEPENDABLE PUSH/PULL LATCHES

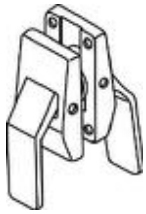

**TRIMCO# 1562A**  
BS 5" (1505) \*  
STR 2-3/4" (3651) \*  
Br, Bz, Pl, SS  
**Push/Pull Latch**  
**Levers Down**

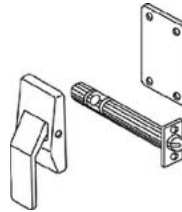

**TRIMCO# 1562AE**  
BS 5" (1505) \*  
STR 2-3/4" (3651) \*  
Br, Bz, Pl  
**Exit only latch lever down**  
 Exit only - Used when only one side of the opening is designed for entrance or exit. Ideal for secured areas. Must specify handing.

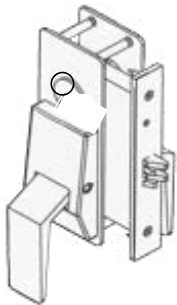

**TRIMCO# 1562Q or 1562M**  
BS 2-3/4"  
STR 4-7/8"  
Br, Bz, Pl, SS  
**Push/Pull Mortise Lock Levers Down**  
 Customer to apply Cylinder



**TRIMCO# 1563A**  
BS 5" (1505) \*  
STR 2-3/4" (3651) \*  
Br, Bz, Pl  
**Push/Pull Latch Levers Up**  
 Must specify handing.

**Note:** PDQ mortise chassis supplied as standard. (Q)

Alternate (M) Corbin Russwin chassis available at an additional cost & lead-time.

**1562Q55 Classroom Function**  
 Auxiliary latch deadlocks latch-bolt. (Standard)  
**1562Q30 Privacy/Bathroom**  
 Deadbolt by thumb-turn lever inside or by emergency release tool outside.  
**1562Q65 Dormitory/Entrance**  
 Deadbolt by key outside or by thumb-turn lever inside.  
 Other functions available.

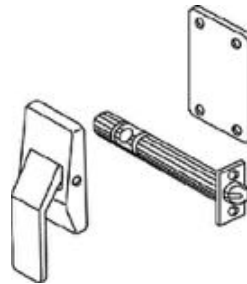

**TRIMCO# 1591A**  
BS 5" (1505) \*  
STR 2-3/4" (3651) \*  
Br, Bz, Pl  
**Reverse Push or Pull Latch**  
 Requires monitoring personnel to maintain pressure on lever paddle to prevent subject from exiting room. Made to order, may not be returned. Must specify handing.

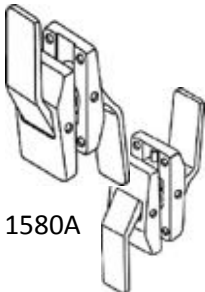

1580A

1581A

**TRIMCO# 1580A**  
BS 5" (1505) \*  
STR 2-3/4" (3651) \*  
Br, Bz, Pl, SS  
**Push/Pull Latch, Push Up, Pull Down**  
 Specify 1581A for Push Down, Pull Up. Must Specify Handing.

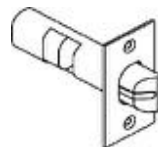

**TRIMCO# 1502 1503 1505**  
BS 2-3/4" 3-3/4" 5"  
Br, Bz, Pl  
**Backset Latchbolt**  
 Push/Pull latch only  
 Latchbolts for 1500 series

**NOTE:** Add suffix "P" to part number to have levers engraved "Push" and "Pull".  
**1592LLE** (Lead Lined Escutcheon Plate) and **1592LLT** (Lead Lined Latch Tube) may be specified by buyer at extra cost.  
 Specify **1592RK** Replacement Kit to replace latches on doors originally prepped for Roller Latch with Push/Pull Latch.  
 \*Either 2-3/4", 3-3/4" or 5" backset and 2-3/4" strike (**3651**) are supplied standard with Push/Pull latches. 7" backset and/or ASA 4-7/8" (**3652**) Strike must be specified by buyer at extra cost.

**Patent #4003593 & 4986583**

DP = Depth, OA = Overall size, BS = Back set, STR = Strike

# QUIET COORDINATORS & ACCESSORIES

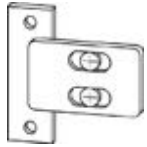

**TRIMCO# 3090**  
 OA 1-1/2" x 2-7/8"  
 Br, Bz, Pl

**Carry Open Bar Assembly**  
 For 3090 Series Coordinators.  
 Maximum adjustment 1/2"



**TRIMCO# 3093**  
 OA 2-5/16" x 6-9/16"  
 BHMA 4.1.1 Type 25  
 Br, Bz, Pl

**Coordinator - Cast**  
 Drop arm type. Two nylon rollers and set screw adjustment standard.



**TRIMCO# 3092**  
 OA 1-5/8" X 5/8" X 18"  
 BHMA 4.1.1 Type 25  
 600 Black

**Retracting Door Coordinator**  
 For use on pairs of doors with or without astragal.  
 Not for use on unequal pairs of doors or with exposed vertical rods. For openings 72" to 96"



TRIMCO#	3094A2	3094B1	3094B2	3094B3
W (of opening)	43" - 53"	53" - 63"	63" - 75"	75" - 87"
BHMA	4.1.1 Type 21	4.1.1 Type 21	4.1.1 Type 21	4.1.1 Type 21
Coordinator Size	32"	52"	52"	52" 600 Black

**Stop Mounted Coordinator with Filler Bar - Patent #5033234**



TRIMCO#	3094B4	3094C4	3094D
W (of opening)	87" - 95"	95" - 107"	Special Application
BHMA	4.1.1 Type 21	4.1.1 Type 21	4.1.1 Type 21
Coordinator Size	52"	60"	Custom Size 600 Black

**Stop Mounted Coordinator with Filler Bar - Patent #5033234**

**3094** Easily configured for unequal pairs of doors. When ordering coordinators, specify opening width, leaf sizes, and finish of companion hardware. Panic Strike preps available.



TRIMCO#	3094-1	3094-2	3094-3	3094-4	3094-5	3094-6
OA	12"	24"	36"	48"	60"	72"

**Filler Bar Only**  
 For the 3094 Coordinator. For mounting stop-applied hardware. In conjunction with the 3094.



**TRIMCO# 3095**  
 OA 3-1/4" x 5"  
 SW 7/8" - 2-1/4"  
 M Steel

**Mounting Bracket** 600 Black  
 For mounting stop-applied hardware. In conjunction with the 3094.



**TRIMCO# 3096**  
 OA 3" x 5"  
 S over 2-1/4"  
 M Steel

**Mounting Bracket** 600 Black  
 For mounting stop-applied hardware. In conjunction with the 3094.



OA = Overall size, BS = Back set, STR = Strike, M = Material

# DRAWER PULLS & ACCESSORIES



TRIMCO#	BP1	BP2	BP3	BP4
D	1"	1-1/4"	1-1/2"	2"
T	1/8"	1/8"	1/8"	1/8"

Br, Bz, Pl, SS

**Back Plates**  
for Pulls 1/8" thick



TRIMCO#	562-3	562-4	562-96mm
OA	3-13/16"	4-5/16"	104mm
CTC	3-1/2"	4"	96mm
CL	7/8"	7/8"	7/8"
D	5/16"	5/16"	5/16"
BHMA	B02012	B02012	B02012

**Drawer Pull**

Br, Bz, Pl, SS



TRIMCO#	*571-3-710CU	571-6	571-8	571-10
CTC	3"	6"	8"	10"
D	6"	1/2"	1/2"	1/2"
O/A	5-1/2"	8"	10"	12"

**CABINET PULL**



TRIMCO#	553
OA	5/8" x 3-1/4"
CTC	3"
CL	3/4"
BHMA	B02012

**Drawer Pull**

Br, Bz, Pl



TRIMCO#	1198-1-XX.710CU
OD	1-1/4"
Sizes 12", 18", 24", 30", 36", 42", 48"	
XX= bar size.	
Bactericidal Copper Grab Bar	

**Also available in Stainless Steel**

**TRIMCO # 1198-1-XX-.630**

SS



D= Diameter, T= Thickness, CL = Clearance, CTC = Center to center, G = Grip, OA = Overall size, P = Projection

# PULLS, PUSH & PULL PLATE SETS



TRIMCO#	1001-1	1001-2	1001-3	1001-3P
OA	3" x 12"	3-1/2" x 15"	4" X 16"	4" X 16"
				Black Plastic 1/8"
BHMA	J301	J301	J301	J301
				Br, Bz, Pl, SS

TRIMCO#	1001-9	1001-11
OA	6" x 16"	8" x 16"
BHMA	J301	J301

### Push Plate .050

Plastic Plates - .125 other standard colors and clear available.



TRIMCO#	1010-1	1010-2	1010-3
OA	3" x 12"	3-1/2" x 15"	4" X 16"
P	1-7/8"	1-7/8"	1-7/8"
G	1117-1	1117-1	1117-1
CL	1-1/2"	1-1/2"	1-1/2"
CTC	5"	5"	5"
BHMA	J405	J405	J405

Br, Bz, Pl, SS

### Pull Plate - .050



TRIMCO#	1012-2	1012-3
OA	3-1/2" x 15"	4" X 16"
P	2"	2"
G	1109-1	1109-1
CL	1-1/2"	1-1/2"
CTC	5-1/2"	5-1/2"
BHMA	J405	J405

Br, Bz, Pl,

### Pull Plate - .050



**NOTE:** All Metal Plates on this page are 0.50" thick. Custom sizes available.



TRIMCO#	1102S	1102T
OA	7-1/2"	7-1/2"
P	2-3/16"	2-3/16"
CL	1-1/2"	1-1/2"
CTC	5-1/2"	5-1/2"
BHMA	J401	J401
	Surface Mount	Thru-bolt Mount

### Pull Cast



Br, Bz, Pl, Al



TRIMCO#	1109-1
OA	6-3/16"
P	1-7/8"
CL	1-1/2"
CTC	5-1/2"
BHMA	J401

Br, Bz, Al, Pl

### Pull Cast



CL = Clearance, CTC = Center to center, G = Grip, OA = Overall size, P = Projection

# PULL PLATES



TRIMCO#	1013-2	1013-2B	1013-3	1013-3B
OA	3-1/2" x 15	3-1/2" x 15"	4" x 16"	4" x 16"
P	2"	2"	2"	2"
G	1193-1	1193-2	1193-1	1193-2
CL	1-1/2"	1-1/2"	1-1/2"	1-1/2"
CTC	5-1/2"	8"	5-1/2"	8"
BHMA	J405	J405	J405	J405

Br, Bz, Al, SS

## Pull Plate



TRIMCO#	1014-2	1014-2B	1014-3	1014-3B
OA	3-1/2" x 15	3-1/2" x 15"	4" x 16"	4" x 16"
P	2"	2"	2"	2"
G	1199-1	1199-2	1199-1	1199-2
CL	1-1/2"	1-1/2"	1-1/2"	1-1/2"
CTC	6"	8"	6"	8"
BHMA	J405	J405	J405	J405

Br, Bz, Al, SS

## Pull Plate



TRIMCO#	1015-2	1015-2B	1015-3	1015-3B
OA	3-1/2" x 15	3-1/2" x 15"	4" x 16"	4" x 16"
P	2"	2"	2"	2"
G	1139-1	1139-2	1139-1	1139-2
CL	1-1/2"	1-1/2"	1-1/2"	1-1/2"
CTC	6"	8"	6"	8"
BHMA	J405	J405	J405	J405

Br, Bz, Al, SS

## Pull Plate



**Note:** All plates on this page are .050" thick. "B&C" suffix indicates larger size grip. Custom Sizes available.

CL = Clearance, CTC = Center to center, G = Grip, OA = Overall size, P = Projection

# PULL PLATES (CONT.)



TRIMCO#	1017-2	1017-2B	1017-3	1017-3B	1017-3C
OA	3-1/2" x 15	3-1/2" x 15"	4" x 6"	4" x 16"	4" x 16"
P	2"	2"	2"	2"	2"
G	1194-1	1194-2	1194-1	1194-2	1194-3
CL	1-1/2"	1-1/2"	1-1/2"	1-1/2"	1-1/2"
CTC	6"	8"	6"	8"	10"
BHMA	J705	J705	J705	J705	J705

Br, Bz, Al, SS

## Pull Plate



TRIMCO#	1018-2	1018-2B	1018-3	1018-3B
OA	3-1/2" X 15"	3-1/2" X 15"	4" x 16"	4" X 16"
P	3-1/8"	3-1/8"	3-1/8"	31/8"
G	1195-1	1195-2	1195-1	1195-2
CL	2"	2"	2"	2"
CTC	8"	10"	8"	10"
BHMA	J405	J405	J405	J405

Br, Bz, Al, SS

## Pull Plate - .050



TRIMCO#	1056-4
OA	1/16" x 8" x 16"
P	1-7/8"
G	1139-2
CL	1-1/2"
CTC	8"
BHMA	J405

Br, Bz, SS

## Pull Plate - .050" thick

Specify **1041-4** for plate only.



CL = Clearance, CTC = Center to center, G = Grip, OA = Overall size, P = Projection

# FLUSH/POCKET PULLS



<b>TRIMCO#</b>	<b>1059</b>
OD	2-1/2"
ID	1-3/4"
DP	7/8"

**Flush Cup Pull** Br, Bz, Pl  
 Use #7059 for fOCAL styling.



<b>TRIMCO#</b>	<b>1060</b>	<b>1061</b>
OA	2-3/4" x 4-1/4"	21/16" x 3-1/8"
DP	13/16"	5/8"
BHMA	J403	J403

**Flush Pull** Br, Bz, Pl  
 Fine finish casting with black interior.  
 Specify for same finish inside and outside cup.



<b>TRIMCO#</b>	<b>1062</b>
OA	5/16" x 1" x 4-1/4"

**Concealed Door Pull** Br, Bz, Pl  
 Non-handed. Side Mount.  
 Mortises into edge and face of pocket door.



<b>TRIMCO#</b>	<b>1063</b>
OA	3/4" x 3-7/8"

**Concealed Door Pull** Br, Bz, Pl  
 Edge Mount.



<b>TRIMCO#</b>	<b>1064</b>
OA	2-1/2" x 2-3/4"
BHMA	D08021

**Pocket Door Pull** Br, Bz, Pl  
 Passage function. 1-3/8" and 1-3/4" thick doors.  
 For use on doors not requiring privacy.

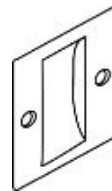

<b>TRIMCO#</b>	<b>1064FCP</b>
OA	2-1/2" x 2-3/4"
BHMA	D02202

**Flush Cup Pull** Br, Bz, Pl  
 Can be used for pairs of doors.



<b>TRIMCO#</b>	<b>1065</b>
OA	2-1/2" x 2-3/4"
BHMA	D08031

**Pocket Door Pull \*** Br, Bz, Pl  
 Privacy function. 1-3/8" thick doors. For use on bathroom doors. Thumb turn on interior, safety release on exterior.



<b>TRIMCO#</b>	<b>1065CD*</b>
OA	2-1/2" x 2-3/4"
BHMA	D08031

**Sliding Door Lock \*** Br, Bz, Pl  
 For use on connecting doors. Thumb turn on both sides.

\*Can be made to fit 1-3/4" thick door, must specify when ordering. P/N 1065CD-175.

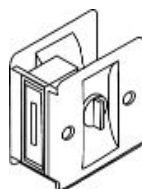

<b>TRIMCO#</b>	<b>1065PA</b>
OA	2-1/2" x 2-3/4"
BHMA	D08031

**Sliding Door Lock \*** Br, Bz, Pl  
 For use on patio and exterior doors. Thumb turn on interior only.

DP = Depth. OA = Overall size, OD = Outside dimension, ID = Inside dimension

# FLUSH PULLS



TRIMCO#	1066S	1066S-516	1066S-38
D	3-9/16"	3-9/16"	3-9/16"
S	9/32"	5/16"	3/8"

Br, Bz, Pl

**Flush Pull - Cast**  
 Spindle Type. Surface Mount.



TRIMCO#	1067	1067-516	1067-38
OA	3" x 3"	3" x 3"	3" x 3"
D	2-1/2"	2-1/2"	2-1/2"
S	9/32"	5/16"	3/8"

Br, Bz, Pl

**Flush Pull - Cast**  
 Spindle Type. Mortise prep. Surface Mount.



TRIMCO#	1068	1068-516	1068-38
D	4-1/4"	4-1/4"	4-1/4"
S	9/32"	5/16"	3/8"

Br, Bz, Pl

**Flush Pull - Cast**  
 Spindle Type. Mortise Prep. Surface Mount.

**NOTE:** Spindle set on diamond standard, can be set on square. Specify. No interference with standard mortise lock case on 1-3/4" doors. There will be an extra charge for special prep, when ordering specify lock set. See order form of this product on our website.

1110-18



1110-10



1110-8



TRIMCO#	1110-8	1110-10	1110-18	1110-CUST
OA	8" x 2-1/2"	10" x 2-1/2"	18" x 2-1/2"	SPECIFY
CO	6-1/2"	8-1/2"	16-1/2"	SPECIFY
DP	3/4"	3/4"	3/4"	SPECIFY

Br, Bz, SS

### FLUSH PULLS - 1110 SERIES

Features concealed screws which are available in standard sizes and can be customized for your project.

OA= Overall size, CO= Cutout, DP= Depth, D= Diameter, S= Spindle

# FLUSH PULLS (CONT.)

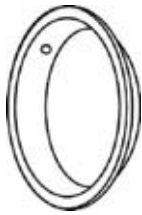

<b>TRIMCO #</b>	<b>242</b>
D	2-1/2"
DP	3/8"

Br, Bz, Pl

**Standard Flush Pull**  
For sliding doors. Stamped.



<b>TRIMCO#</b>	<b>248</b>
OA	1-1/2" x 4"
DP	7/16"

Br, Bz, Pl

**Standard Flush Pull**  
For sliding doors. Stamped.



1111A

<b>TRIMCO#</b>	<b>1111A/1111B</b>
OA	5" x 5"
DP	1-1/8"
BHMA	J403

Br, Bz, SS

**Flush Pull - Anti-Vandal**  
Mounting Lugs on back of Cup. Specify **1111B** for mounting on face. For high-traffic, exposed, rough-service areas. Specially engineered as exit trim on school doors with interior, panic hardware. Easy exterior access during the day; vandal resistant at night. Specify **1111LB** for anti-vandal flush pulls BTB on each side with two shims-clean exterior face plate. torx screws can be supplied if specified.



1111B



<b>TRIMCO#</b>	<b>1111C</b>
OA	6"X6"
DDPP	1-1/2"
BHMA	J403

Br, Bz, SS

**Flush Pull - Anti-Vandal**  
Meets California Access Requirements.

**Also available: 1111C-BTB**



<b>TRIMCO#</b>	<b>1115</b>
OA	3-1/2" x 4-3/4"
DP	13/16"
BHMA	J403

Br, Bz, SS

**Flush Pull**  
Specify **1115B** for pair of 1115 prepped for BTB mounting. For mounting screws in cup, order **1115C**.  
**Also available: 1115P**  
(Pair- prep for BTB with Lugs)



<b>TRIMCO#</b>	<b>1113</b>
OA	1-1/4" x 3"
DP	13/32"

Br, Bz, Pl

**Flush Pull - Cast**  
For sliding doors only.

CL= Clearance, CTC= Center-to-center, M= Material, OA= Overall size,  
P= Projection, OD= Outside diameter, CU = CuVerro

# PULLS & GRIPS

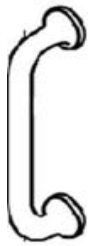

<b>TRIMCO#</b>	<b>1117-1</b>
OA	6-1/8"
P	1-7/8"
CTC	5"
CL	1-1/2"
BHMA	J401
<b>Pull - Cast</b>	
	Br, Bz, Pl
<b>ADA</b>	



<b>TRIMCO#</b>	<b>1120</b>
OA	7-1/2"
P	2-1/2"
CTC	6"
CL	1-7/8"
BHMA	J401
<b>Classic Pitcher Grip - Cast</b>	
	Br, Bz, Pl
<b>ADA</b>	



<b>TRIMCO#</b>	<b>1134</b>
OA	9-1/16"
P	3-1/2"
CTC	5"
CL	2"
BHMA	J401
<b>Hospital Grip - Cast</b>	
	Br, Bz, Pl
Specify <b>1134B</b> for pair of 1134 prepped for back to back mounting.	
<b>ADA</b>	



<b>TRIMCO#</b>	<b>1135</b>
OA	9"
M	3/8" x 3/4"
P	3-3/16"
CTC	6"
CL	2"
BHMA	J401
<b>Hospital Grip</b>	
	Br, Bz, SS
<b>ADA</b>	

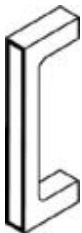

<b>TRIMCO#</b>	<b>1136</b>
OA	7-3/8"
P	2-1/16"
CTC	6-1/4"
CL	1-1/2"
	Br, Bz, Pl
<b>Grip - Cast</b>	
Specify <b>1136G</b> for pair of 1136 prepped for BTB mounting. (Velazquez = Mastercraft Bronze Line)	
<b>ADA</b>	



<b>TRIMCO#</b>	<b>1147</b>
OA	10-1/2"
M	1-1/2" x 1-1/2"
P	2-7/8"
CTC	10"
CL	1-5/8"
BHMA	J402
	SS
<b>Grip</b>	
Specify <b>1147B</b> for pairs, mounted back to back with Mounting Plates. Other lengths available.	
<b>ADA</b>	



<b>TRIMCO#</b>	<b>1139-1</b>	<b>1139-2</b>
OA	6-3/8"	8-3/8"
M	1" x 3/8"	1" x 3/8"
P	1-7/8"	1-7/8"
CTC	6"	8"
CL	1-1/2"	1-1/2"
BHMA	J401	J401
	Br, Bz, Al, SS	
<b>Grip</b>		
<b>ADA</b>		

**NOTE:** All Grips may be mounted to a variety of standard and custom plates.

CL = Clearance, CTC = Center-to-center, M = Material, OA = Overall size, P = Projection, OD= Outside diameter, CU = CuVerro

# GRIPS



TRIMCO#	1150	1151
OA	6-1/2"	8-1/2"
M	1/2" RD	1/2" RD
P	2"	2"
CTC	6"	8"
CL	1-1/2"	1-1/2"
BHMA	J401	J401

**GRIP**

Br, Bz, Pl, SS

Custom back to back mounting available.

ADA



TRIMCO#	1191-1	1191-2	1191-3	1191-4
OA	8-3/4"	10-3/4"	11"	13"
M	3/4" RD	3/4" RD	1" RD	1" RD
P	3-1/4"	3-1/4"	3-1/2"	3-1/2"
CTC	8"	10"	10"	12"
CL	2"	2"	2-1/4"	2-1/4"
BHMA	J402	J402	J402	J402

Br, Bz, Al, Pl, SS

**GRIP – OFFSET**

fOCAL option available.

ADA

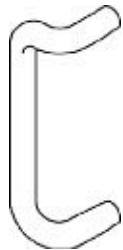

TRIMCO#	1191-4J	1191-5	1191-5J
OA	13-1/4"	19"	19-1/4"
M	1-1/4" RD	1" RD	1-1/4" RD
P	4-1/8"	3-1/2"	4-1/8"
CTC	12"	18"	18"
CL	2-1/4"	2"	2-1/4"
BHMA	J402	J402	J402

Br, Bz, Al, Pl, SS

**GRIP – OFFSET**

fOCAL option available.

ADA



TRIMCO#	1193-1	1193-2
OA	6"	8-1/2"
M	1/2" X 3/4" RD	1/2" X 3/4" RD
P	2"	2"
CTC	5-1/2"	8"
CL	1-1/2"	1-1/2"
BHMA	J401	J401

Br, Bz, Pl, SS

**GRIP**

fOCAL option available.

ADA

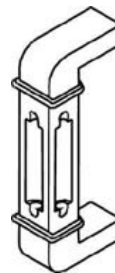

**TRIMCO# 1183-1 / CAIRO**

OA	5-1/2"
P	2-1/8"
CTC	5"
CL	1-1/4"

Br, Bz, Pl

**Grip - Cast**

ADA

CL = Clearance, CTC = Center-to-center, M = Material, OA = Overall size, P = Projection

# GRIPS CONT...

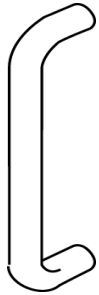

TRIMCO#	1194-1	1194-2	1194-3	1194-4
OA	6-3/4"	8-3/4"	10-3/4"	12-3/4"
M	3/4" Rd	3/4" Rd	3/4" Rd	3/4" Rd
P	2-3/4"	2-3/4"	2-3/4"	2-3/4"
CTC	6"	8"	10"	12"
CL	2"	2"	2"	2"
BHMA	J401	J401	J401	J401

**Grip**

Br, Bz, Pl, SS

Custom back to back mounting available.



TRIMCO#	1195-1	1195-2	1195-3	1195-3J	1195-6	1195-6J
OA	9"	11"	13"	13-1/4"	19"	19-1/4"
M	1" Rd	1" Rd	1" Rd	1-1/4" Rd	1" Rd	1-1/4" Rd
P	3"	3"	3"	3-1/2"	3"	3-1/2"
CTC	8"	10"	12"	12"	18"	18"
CL	2"	2"	2"	2-1/4"	2"	2-1/4"
BHMA	J401	J401	J401	J401	J401	J401

**Grip**

Br, Bz, Pl, SS

fOCAL option is available.



TRIMCO#	1199-1	1199-2
OA	6-1/2"	8-1/2"
M	1" Half Round	1" Half Round
P	2"	2"
CTC	6"	8"
CL	1-1/2"	1-1/2"
BHMA	J401	J401

**Grip**

Br, Bz, Pl, SS



TRIMCO#	1748	1748-1
OA	6-3/4" x 12-3/4"	7" x 13"
M	3/4" Round	1" Round
P	3-3/8"	3-1/2"
CTC	12"	12"
CL	2-5/8"	2-1/2"
BHMA	J402	J402

**Grip Offset**

Br, Bz, Pl, SS

fOCAL option is available. Priced individually. Style plates required, specify.



**NOTE:** These pulls are covered by warranty if ordered with BP4 Back Plates and "L" or "M" mounting.

CL = Clearance, CTC = Center-to-center, M = Material, OA = Overall size, P = Projection, RD = Round

# HEAVY GAUGE PUSH/PULL PLATES

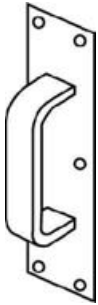

<b>TRIMCO#</b>	<b>1802-4</b>
OA	1/8" x 4" x 16"
P	2"
G	1139-1
PP	1807-4
CL	1-3/4"
CTC	6"
BHMA	J407

**Pull Plate** Br, Bz, Pl  
Beveled top and bottom



<b>TRIMCO#</b>	<b>1802-25</b>
OA	1/8" x 4" x 25"
P	2"
G	1139-1
PP	1807-4
CL	1-3/4"
CTC	6"
BHMA	J407

**Pull Plate** Br, Bz, Pl  
Beveled top and bottom



**Also Available:**

- 1802-25-PL** = Engraved Pull
- 1802-25-PH** = Engraved Push
- 1802-25CC-PL** = with 1-1/4" dia. Cutout X Engraved Pull
- 1802-25CC-PH** = with 1-1/4" dia. Cutout X Engraved Push

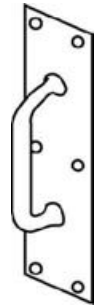

<b>TRIMCO#</b>	<b>1804-4</b>
OA	1/8" x 4" x 16"
P	2-1/4"
G	1117-1
PP	1807-4
CL	1-1/2"
CTC	5"
BHMA	J407

**Pull Plate** Br, Bz, SS  
Beveled top and bottom

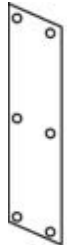

<b>TRIMCO#</b>	<b>1807-4</b>	<b>1807-25</b>	<b>1809-4</b>
OA	1/8" x 4" x 16"	1/8" x 4" x 25"	1/8" x 4" x 16"
BHMA	J304	J304	J304

**Push Plate** Br, Bz, SS  
**NOTE:** Beveled all 4 sides



<b>TRIMCO#</b>	<b>1820</b>	<b>1820-11</b>
OA	1/8" x 3-1/2" x 16-1/2"	1/8" x 8" x 16-1/2"
P	1-1/2"	1-1/8"
CL	1-1/8"	1-1/8"
BHMA	J303	J303

**Push/Pull Plate** Br, Bz, SS



<b>TRIMCO#</b>	<b>1822</b>	<b>1822-1</b>	<b>1822-2</b>
OA	1/8" x 2" x 3-3/4"	1/8" x 2" x 3-3/4"	1/8" x 3" x 4-1/2"
P	7/8"	7/8"	7/8"
CL	3/4"	3/4"	3/4"

**Cylinder Pull** Br, Bz, SS  
For dead bolt only. 2-1/8" opening.

1822-1

1822-2

**NOTE:** All 1800 Series plates are 1/8" thick.

CL = Clearance, OA = Overall size, P = Projection

# PULLS, PUSH & PULL PLATES

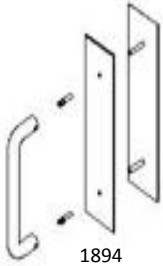

TRIMCO#	1894-3	1895-3	1896-4B
OA	3-1/2" x 15"	3-1/2" x 15"	4" x 16"
CTC	6"	8"	10"
D	3/4"	1"	1"

Br, Bz, SS

**Cylinder Pull Plates**  
 1807 Plate X 1194 Series.  
 Other Sizes Available.  
 Also available in 

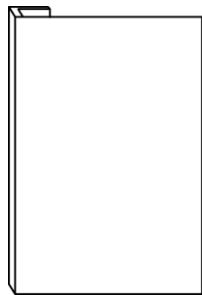
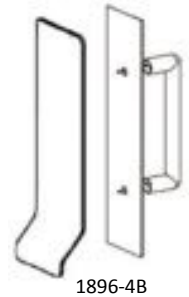

TRIMCO#	9550
OA	3/16" x 6" x 9" Lgth
M	Ext. Aluminum
P	1-1/2"
CTC	7"
CL	1-1/4"

Al

**Push / Pull**  
 Square corners. Smooth, clean surface is ideal for engraving for an additional charge.  
 ADA - when mounted on narrow stile aluminum doors.

**ADA**

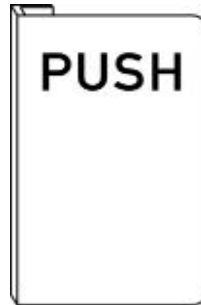

TRIMCO#	9551
OA	3/16" x 6" x 9" Lgth
M	Ext. Aluminum
P	1-1/2"
CTC	7"
CL	1-1/4"

Al

**PUSH**  
 Round corners. Smooth, clean surface is ideal for engraving for an additional cost.  
 ADA - when mounted on narrow stile aluminum doors.

**ADA**



TRIMCO#	9560	9561
OA	3-1/2" x 11-3/8"	3-1/2" x 11-3/8"
M	628 Pull	628 Pull
	x 628 Insert	x Black Insert
P	2-7/8"	2-7/8"
CTC	10"	10"
BR	A	A

AL

**Offset Entrance Door Pull**  
 Aluminum Pull x Insert.  
 Surface or through-bolt mounting.

**ADA**



TRIMCO#	9566
OA	9" Lgth
M	Ext. Aluminum
CTC	7"

Al

**Push / Pull**  
 Smooth, clean surface is ideal for engraving your logo up to 2-1/2" max, for an additional charge. Customize your store front with this pull.  
 ADA - when mounted on narrow stile aluminum doors. Anodizing available at an additional charge. Installs above any type of lock.  
 Made in USA.

**ADA**

BR = Bracket, CL = Clearance, CTC = Center to center, L = length, M = Material, OA – Overall size, P = Projection, D = Diameter

# 1700 SERIES STANDARD PUSH BARS

Trimco's 1700 Series Push Bars are manufactured from solid stainless steel, bronze, brass & aluminum. These heavy duty bars are available with a multitude of mounting options for most applications including steel, wood and glass doors. Available in most architectural finishes.

- Options include 3/4", 1" and 1-1/4" diameter material and 10", 12" or 18" pulls
- Multiple mounting options for metal, wood and glass doors
- Custom sizes and finishes also available
- ADA compliant
- Back-to-Back mounting available
- For additional finish options contact customer service
- Specifying Push Bar Size (CTC) –
- Example 1 • 32" CTC, specify as 3200
- Example 2 • 33-1/2" CTC, specify as 3350
- \* For J & M mounting options, specify Riv-Nut for metal doors or bushings for wood doors if required
- \*\* Glass Door Mounting options for 3/8" & 1/2" door thicknesses require a W-Mount hardware kit



1700 Series Push Bar

# 1700 SERIES

## STANDARD PUSH/PULL BAR SETS

### HOW TO SPECIFY AND ORDER

# 1729EG-3350-4.630

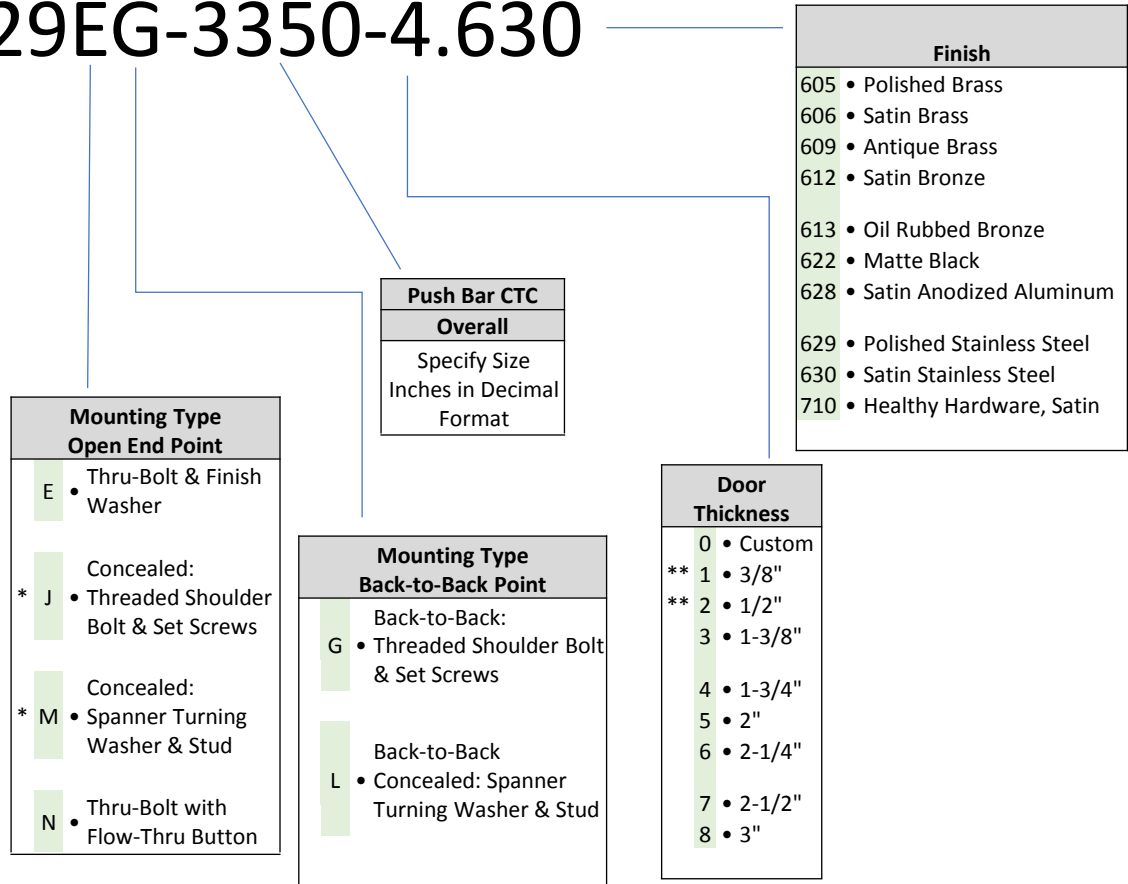

Mounting Type Open End Point	
E	• Thru-Bolt & Finish Washer
* J	• Concealed: Threaded Shoulder Bolt & Set Screws
* M	• Concealed: Spanner Turning Washer & Stud
N	• Thru-Bolt with Flow-Thru Button

Push Bar CTC Overall
Specify Size Inches in Decimal Format

Mounting Type Back-to-Back Point	
G	• Back-to-Back: Threaded Shoulder Bolt & Set Screws
L	• Back-to-Back: Concealed: Spanner Turning Washer & Stud

Door Thickness	
0	• Custom
** 1	• 3/8"
** 2	• 1/2"
3	• 1-3/8"
4	• 1-3/4"
5	• 2"
6	• 2-1/4"
7	• 2-1/2"
8	• 3"

Finish	
605	• Polished Brass
606	• Satin Brass
609	• Antique Brass
612	• Satin Bronze
613	• Oil Rubbed Bronze
622	• Matte Black
628	• Satin Anodized Aluminum
629	• Polished Stainless Steel
630	• Satin Stainless Steel
710	• Healthy Hardware, Satin

Family	Description
<b>1700</b>	<b>STRAIGHT PULLS</b>
1729	3/4" dia., 10" CTC Straight Pull
1731	1" dia., 10" CTC Straight Pull
1732	1" dia., 12" CTC Straight Pull
1746	1-1/4" dia., 18" CTC Straight Pull
1746-1	1-1/4" dia., 12" CTC Straight Pull
<b>1700</b>	<b>OFFSET PULLS</b>
1737	1" dia., 10" CTC Offset Pull
1738	1" dia., 12" CTC Offset Pull
1747	1-1/4" dia., 18" CTC Offset Pull
1747-1	1-1/4" dia., 12" CTC Offset Pull

# 1700 SERIES

## STANDARD PUSH/PULL BAR SETS

Trimco's 1700 Series Push/Pull Bars & Sets are manufactured from solid stainless steel, bronze, brass & aluminum. These heavy duty bars are available with a multitude of mounting options for most applications including steel, wood and glass doors. Available in most architectural finishes.

- Options include 3/4", 1" and 1-1/4" diameter material and 10", 12" or 18" pulls.
- Multiple mounting options for metal, wood and glass doors.
- Custom sizes and finishes also available.
- For additional finish options contact customer service
- Specifying Push Bar Size (CTC) –
- Example 1 • 32" CTC, specify as 3200.
- Example 2 • 33-1/2" CTC, specify as 3350.
- \* For J & M mounting options, specify Riv-Nut for metal doors or bushings for wood doors if required.
- \*\* Glass Door Mounting options for 3/8" & 1/2" door thicknesses require a W-Mount hardware kit.
- Handing specification is required for J & M mounting options on models 1737, 1738, 1747 & 1747-1 only.

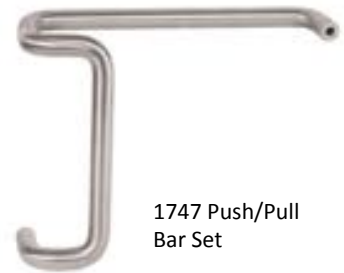

1747 Push/Pull  
Bar Set

# 1700 SERIES

## STANDARD PUSH BARS

### HOW TO SPECIFY AND ORDER

# 1740EG-3350-4.630

Family	Description
<b>1700</b>	<b>PUSH BARS</b>
1740	3/4" Diameter
1741	1" Diameter
1745	1" Diameter

Push Bar CTC
Overall
Specify Size Inches in Decimal Format

Door Thickness
0 • Custom
**1 • 3/8"
**2 • 1/2"
3 • 1-3/8"
4 • 1-3/4"
5 • 2"
6 • 2-1/4"
7 • 2-1/2"
8 • 3"

Finish
605 • Polished Brass
606 • Satin Brass
609 • Antique Brass
612 • Satin Bronze
613 • Oil Rubbed Bronze
622 • Matte Black
628 • Satin Anodized Aluminum
629 • Polished Stainless Steel
630 • Satin Stainless Steel
710 • Healthy Hardware, Satin

Mounting Type	
EG	• Thru-Bolt x Back-to-Back
EJ	• Thru-Bolt x Concealed
E	• Thru-Bolt & Finish Washer
G	• Back-to-Back: Threaded Shoulder Bolt & Set Screws
* J	• Concealed: Threaded Shoulder Bolt & Set Screws
L	• Back-to-Back Concealed: Spanner Turning Washer & Stud
* M	• Concealed: Spanner Turning Washer & Stud
N	• Thru-Bolt with Flow-Thru Button

# 1640 SERIES MULTI-RAIL PUSH BARS

The Trimco 1640 Series Push Bars offer classic style and master craftsmanship in 2, 3 and 4 bar options. The 1640 Series brackets are cast from solid bronze or brass and are mated with 5/8" rod to complete the package. Center-to-center dimensions must be specified when ordering. Let Trimco's 1640 Series Push Bars add that classic touch to your project.



- Classic styling offered in 2, 3 or 4 bar options
- Manufactured in the United States
- Brackets are cast from durable bronze or brass while bars are 5/8" tube
- Offered in most architectural finishes
- Surface mounting standard
- For additional finish options contact customer service
- Specifying Push Bar Size (CTC) –
  - Example 1 • 32" CTC, specify as 3200
  - Example 2 • 33-1/2" CTC, specify as 3350

## HOW TO SPECIFY AND ORDER

# 1642-3200.630

Family	Description
<b>1640</b>	
1642	5/8" dia., 2 Bar Set
1643	5/8" dia., 3 Bar Set
1644	5/8" dia., 4 Bar Set

Size CTC
<b>Overall</b>
Specify CTC Inches in Decimal Format

Finish	
605	• Polished Brass
606	• Satin Brass
609	• Antique Brass
612	• Satin Bronze
613	• Oil Rubbed Bronze
622	• Matte Black
628	• Satin Anodized Aluminum
629	• Polished Stainless Steel
630	• Satin Stainless Steel
710	• Healthy Hardware, Satin

# ANTI-VANDAL TRIM & PULLS

## Options Available

SP = Lugs mated to dead bolt, panics, rim and exit device. FC = Flush Cylinder. Specify 1-1/4" dia. NC = No Cylinder Cutout. BTB = Special Back-to-Back Mounting. Specify Handing. ADA. Available:  (without PVC coating)



### **TRIMCO# 1096TL TUF-LOK System**

Anti Vandal Trim System includes: 1562Q Push latch with modified paddle, the Anti-Vandal Trim Pull handle, and Mortise lock. **Customer supplies the cylinder.**



### **TRIMCO# 1097TL**

Anti Vandal Trim System includes: 1562Q Push Latch with modified paddle, the Anti-Vandal Trim Pull handles, and Mortise lock. **Customer supplies the cylinder. Without Astragal.**

## Options Available

XX = Lugs mated to Mortise Lock if other than PDQ. FC = Flush Cylinder. Specify 1-1/4" or 1-1/2" dia. Available:  (without PVC coating)

### **TRIMCO# 1098RG –Outswing Dr. Safety and Security Lock Set – For Outswing Doors**



For details see 1098RG brochure Supplied with mortise lock I.C. cylinder, PDQ cylindrical lever set with and without hold back feature, interior lever, small or large format. With Astragal. Available:  (without PVC coating)



### **TRIMCO# 1099RG–Inswing Door Safety and Security Lock Set – For Inswing Doors**

For details see 1098RG brochure Supplied with mortise lock I.C. cylinder, PDQ cylindrical lever set with and without hold back feature, interior lever, small or large format. No Astragal. Available:  (without PVC coating)

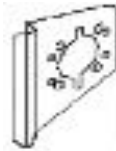
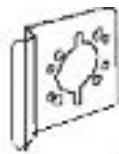

TRIMCO#	1082-4	1082-6	1082-8
OA	4"X 5-3/8"	4X6X5-3/8"	2-7/8"X 8"

SS

### **Cylindrical Lock Guards**

Installs in minutes to retrofit or for new construction.

**Note:** 1082-8 order as follows: 1082-8-RHR pr 1082-8-LHR Cylinder hole 1-1/4" dia., CTC of mtg posts 7", Backset 1-1/8"

# ANTI-VANDAL TRIM & PULLS



<b>TRIMCO#</b>	<b>1096HA</b>
OD	3-5/8"
ID	2-3/16"

**Anti-Vandal Trim Handle Only**  
Same Anti-Vandal Trim used in TUF-LOK System, but Trim handle only.



<b>TRIMCO#</b>	<b>1097HA</b>
OD	3-5/8"
ID	2-3/16"

**Without Astragal**



<b>TRIMCO#</b>	<b>1096VD98-99HA</b>
Face	6-5/8" x 11"
Grip	Black PVC

SS

**Anti Vandal Pull**  
Made to work with Von Duprin 98 or 99 Exit Device, Cylinder rotated 90° for non-handing. Each pull comes with a cylinder holder. Made from 316 SS. Also available: Anti-vandal pull with no cylinder: 1096VD98-99HA-NC



<b>TRIMCO#</b>	<b>1097VD98-99HA</b>
Face	2-5/8" x 11"
T	1/8"
Grip	Black PVC

SS

**Anti Vandal Pull-NARROW LOOK**  
Made to work with Von Duprin 98 or 99 Exit Device, Cylinder rotated 90° for non-handing. Each pull comes with a cylinder holder. Also available: Antivandal pull with no cylinder- 1097VD-98-99HA-NC



<b>TRIMCO#</b>	<b>1096-PHI</b>
----------------	-----------------

SS

**Anti Vandal Pull**  
Mated to Precision Apex 2000 Series exit devices. **1096** with Astragal.

ADA



<b>TRIMCO#</b>	<b>1096-PHI-NC</b>
----------------	--------------------

SS

**Anti Vandal Pull**  
Mated to Precision Apex 2000 Series exit devices. **1096** without Astragal.

ADA



<b>TRIMCO#</b>	<b>1097-PHI</b>
----------------	-----------------

SS

**Anti Vandal Pull**  
Mated to Precision Apex 2000 Series exit devices. **1097** with Astragal.

ADA



<b>TRIMCO#</b>	<b>1097-PHI-NC</b>
----------------	--------------------

SS

**Anti Vandal Pull**  
Mated to Precision Apex 2000 Series exit devices. **1097** without Astragal.

ADA

# RUGGED, STYLISH PUSH & PUSH/PULL BARS

1630



TRIMCO#	1630	1630B
P	3/4"	3/4" exterior, 7/8" interior bar
CTC	Specify	Specify
M	3/8" x 2-1/2"	3/8" x 2-1/2"
BHMA	J501	J501
	<b>Push Bar</b>	<b>Push Bar</b>
	Single - bar	Single - bar

Br, Bz, Pl, SS



1633-1

TRIMCO#	1633-1
P	3-1/4"
CTC	14"
M	3/8" x 1-1/2"

Br, Bz, Pl, SS

**Push Bar**  
 Single - bar

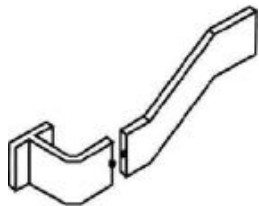
TRIMCO#	1633
P	3-1/8"
CTC	Specify
M	3/8" x 2-1/2"
BHMA	J501

Br, Bz, Pl, SS

**Push Bar**  
 Single - bar

TRIMCO#	1637
P	2-1/2"
CTC	Specify
M	3/8" x 1-1/4"
BHMA	J501

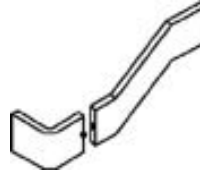
Br, Bz, Al, SS, Pl

**Push Bar**  
 Single - bar



TRIMCO#	J1637
P	2-1/2"
CTC	Specify
M	3/8" x 1-1/4"
BHMA	J501
	Less pad

S



TRIMCO#	1698
P	2-3/8"
CTC	Specify
M	3/8" x 2-1/2"
CL	2"
BHMA	J501

Br, Bz, Pl, SS

**Push Bar**  
 Single - bar

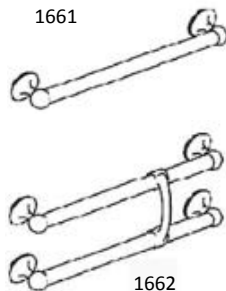
**NOTE:** "J" hook only for the 1637 Push Bar.

1661

1662

TRIMCO#	1661	1662
D	1"	1"
P	2-1/2"	2-1/2"
GP		3-1/2"
CTC	Specify	Specify
M	1" OD Tube	1" OD Tube
BHMA	J501	J502
	Single Bar	2 Bar and Grip

**Push Bar Set**

Br, Bz, Pl

**NOTE:** Push/Pull Bars and Sets are custom made and not returnable. Specify center to center where appropriate.

 CTC= Center to center, M= Material, OA= Overall size, P= Projection, BR= Brackets,  
 D= Diameter, GP= Grip projection

# STOPS & HOLDERS



TRIMCO#	1200	1201	1201-5	1201CK
B	2-1/4"	2-1/4"	3"	2-1/4"
H	3-1/8"	3"	5"	3"
BHMA	L02131	L02131	L02131	L02131

Br, Bz, Pl, SS

### Floor Stop - Cast

**1201CK** is a heavy - duty, high-abuse school design with reduces tampering and loss of rubber on bumper. For surface mounting with wood screws, use **1200**.



TRIMCO#	1204
P	3-1/8"
CTC	Specify
M	3/8" x 2-1/2"
BHMA	J501

Br, Bz, Pl

### Base Stop

For surface mounting with wood screws, use **1204**.



TRIMCO#	1205
P	3-1/8"
CTC	Specify
M	3/8" x 2-1/2"
BHMA	J501

Br, Bz, Pl

### Base Stop



TRIMCO#	1206
P	3-1/8"
CTC	Specify
M	3/8" x 2-1/2"
BHMA	J501

Br, Bz, Pl

### Base Stop and Holder - Cast

For surface mounting with wood screws, use **1206**.



TRIMCO#	1207
B	2-1/4"
P	3-3/4"
EYE	7/8" x 2-1/4"
HOOK	2-3/4"
BHMA	L01351

### Base Stop and Holder - Cast



TRIMCO#	1208
B	1-3/16"
P	3-11/32"
BHMA	L02031

Br, Bz, Pl

### Base Stop - Cast

Wood screws.



TRIMCO#	1209
B	1-1/4"
H	2"

Pl

### Heavy - Duty Stop

Ideal for high-abuse installations like prisons, schools, heavy doors. Installs with quick-set cement. Requires 1-1/2" diameter cored hole. Available for wall mount **1209W**, hold open feature **1209HO**, and **1209HA** with extra strong stainless steel shaft and larger rubber.

CTC= Center to center, M= Material, OA= Overall size, P= Projection, B= Base

# STOPS & HOLDERS (CONT.)



<b>TRIMCO#</b>	<b>1209HA</b>
B	1" dia
H	3" Rubber

SS

**Extra Heavy Duty Door Stop**  
5" long, 1" dia Stainless Steel shaft. Also available in **1209HAHO** with hold open feature **1209HO**, and **1209HA** with extra strong stainless steel shaft and longer rubber.



<b>TRIMCO#</b>	<b>1211</b>
R	.22"
B	1-1/2"
H	1.43"
M	CAST
BHMA	L02141/L02161

Br, Bz, Pl

**Universal Dome Stop**



<b>TRIMCO#</b>	<b>1211CH</b>	<b>1211CL</b>
R	3/4"	1/2"

Al

**Carpet Riser**  
Specify Stop Finish  
**For cast 1211 Dome Stop**



<b>TRIMCO#</b>	<b>W1211</b>
R	1/8"
B	1-3/4" x 2"
H	1"
M	Wrought
BHMA	L02141

Br, Bz, SS

**Universal Dome Stop**  
Patent # 4209876



<b>TRIMCO#</b>	<b>1214</b>	<b>1214H</b>	<b>1214CK</b>
B	1-3/4" x 2-1/2"	1-3/4" x 2-1/2"	1-3/4" x 2-1/2"
H	1-3/4"	2-1/4"	2-1/4"
BHMA	L02121		

Br, Bz, Pl

**Door Stop - Cast**

Heavy - Duty. (3 fasteners)

1214CK is a heavy duty, high-abuse, school design which reduces tampering and loss of rubber bumper. **1214CK** supplied with torx screws.



<b>TRIMCO#</b>	<b>1214CK x 1268CK</b>
OA	5-7/8" x 2-1/2"

**Heavy-Duty Stop**

Pinned, screwed and recessed rubber resists vandalism. Torx. Requires 3" diameter cored hole and Quick-crete.

CTC = Center to center, M = Material, OA = Overall size, P = Projection, B = Base, R = Rise

# STOPS & HOLDERS (CONT.)

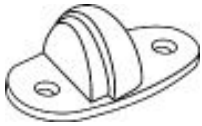

TRIMCO#	1215CKU
H	1-1/2"
L	3/16"
CTC	2-1/5"

Br, Bz, Pl

### Universal Stop

Supplied with Torx  
Screws upon request for  
an additional charge.

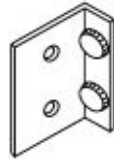

1217P

TRIMCO#	1217P	1217S
OA	1-1/2" x 2"	1-1/2" x 2"
	Pair of Doors	Single Doors

### Angle Stop

For use on stopless frames.



TRIMCO#	1220-5	1221-4	1221-4FF
B	1-3/8" x 2"	1-3/8" x 2"	1-3/8" x 2"
H	5-25/32"	4-27/32"	4-27/32"
F	Full Finish	Spray Finish	Full Finish
BHMA	L01391	L01381	L01381

Br, Bz, Pl

### Door Holder - Cast



TRIMCO#	1223
B	2-1/4"
H	3-5/8"
FASTENERS	Wood Screws
EYE	7/8" x 1-1/2"
HOOK	2-3/4"
BHMA	L01371

### Floor Stop/Holder - Cast



TRIMCO#	1224	1224-5
B	2-1/4"	2-7/8"
H	3-5/8"	5-3/4"
FASTENERS	Combo Pack	Combo Pack
EYE	7/8" x 1-1/2"	7/8" x 2-1/4"
HOOK	2-3/4"	2-3/4"
BHMA	L01371	L01371

Br, Bz, Pl

### Floor Stop / Holder - Cast

Combo Pack. For surface mounting  
with wood screws, use **1223**.

**NOTE:** Combo Pack - See page 1.

B = Base, F = Finish, H = Height, OA = Overall size, P = Projection, R = Rise

# STOPS & HOLDERS (CONT.)

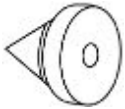

**TRIMCO# 1229A**  
 OA 1/2" x 1/2"  
 BHMA L03011  
**Silencers for Metal Frames**  
 Sold in multiples of 100.

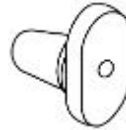

**TRIMCO # 1229B**  
 OA 5/8" x 3/4"  
 BHMA L03021  
**Silencers for Wood Frames**  
 Sold in multiples of 100 .

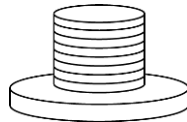

**TRIMCO# 1229EL**  
 H 1/4"  
 D 1-1/8"  
**Elevator Bumper - Grey**  
 Sold in multiples of 125.



TRIMCO#	1231	1233
B	1-5/8" x 2-1/2"	1-3/8" x 2-3/4"
H	2"	2-7/8"
BHMA	L02181	L02181

**Floor Stop - Cast**  
 Combo Pack

Br, Bz, Pl



**TRIMCO# 1234**  
 B 1-1/2" x 2-3/4"  
 H 3"  
 STR 1" X 2"  
 BHMA L01361

**Floor Stop, Holder - Cast**  
 Combo Pack

Br, Bz, Pl



**TRIMCO# 1235**  
 B 1-3/8"  
 P 2-15/16"  
 BHMA L02041

**Base Stop - Cast**  
 Wood screws.

Br, Bz, Pl

**NOTE:** Combo Pack - See page 1.

B = Base, H = Height, OA = Overall size, P = Projection, STR = Strike

# STOPS & HOLDERS CONT...



<b>TRIMCO#</b>	<b>1240</b>
DO	70° to 100°

**Hinge Pin Stop**  
619 Finish only.



<b>TRIMCO#</b>	<b>1244</b>	<b>1244-6</b>
B	2"	2"
P	4-1/4"	6"
BHMA	L02191	L02201

**Roller Stop - Cast**

Bz, Pl



<b>TRIMCO#</b>	<b>1245</b>
B	1-11/16" x 2-1/4"
P	3"
BHMA	L02211

**Roller Stop - Cast**

Br, Bz, Pl

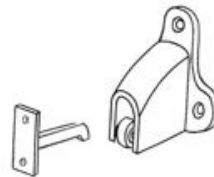

<b>TRIMCO#</b>	<b>1254</b>
OA	2-3/4" x 2-1/2"
STR	1" x 2"
STR-P	2-1/8"
BHMA	L01291

**Holder / Wall Strike - Cast**  
Combo Pack.

Br, Bz, Pl



<b>TRIMCO#</b>	<b>1255</b>
L	7-1/16"
W	2-7/16"
TH	1-3/4"
BHMA	L01411

**Plunger Door Holder - Cast**

Extra rugged cast brass or bronze.

Br, Bz, Pl

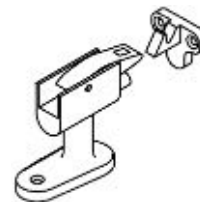

<b>TRIMCO#</b>	<b>1257M</b>
B	3-1/4" x 1-3/4"
H	2-3/4"
STR	1-5/8" x 2"
BHMA	L01241

**Heavy Duty Floor Stop - Cast**  
Machine screw & expansion shield.

Br, Bz, Pl



<b>TRIMCO#</b>	<b>1257R</b>
OA	6" x 8-3/8"
H	5"
BHMA	L01241

**Riser for the 1257 Series Stop - Cast**  
Sprayed to match.

Al



<b>TRIMCO#</b>	<b>1258M</b>
B	3-1/4" x 1-3/4"
H	2-3/4"
STR-D	1-1/4"

**Heavy Duty Floor Stop - Cast**  
Machine screw & expansion shield.

Br, Bz, Pl

**NOTE:** Combo Pack - See page 1.

B = Base, H = Height, L = Length, OA = Overall size, P = Projection, STR = Strike, TH = Throw, W = Width, STR-D = Strike diameter, STR-P = Strike projection, DO = Door opening

# STOPS & HOLDERS CONT...



TRIMCO#	1260W	1261	1263
OA	3-1/16" x 3-1/2"	3-1/16" x 3-1/2"	3-1/16" x 3-1/2"
C		1/2"	9/16" - 1-1/16"
P-Holder	2"	2"	2"
P-Strike	2-1/2"	1-1/4"	1-3/4"
BHMA	L01301	L01301	L01301
	Wall Strike	Floor Strike	Floor Strike

Br, Bz, Pl

### Door Holder and Strike - Cast

TRIMCO#	1265	1267
OA	3-1/16" x 3-1/2"	3-1/16" x 3-1/2"
C	1-1/8" x 1-9/16"	1-5/8" x 2-1/16"
P-Holder	2"	2"
P-Strike	2-1/4"	2-3/4"
BHMA	L01301	L01301
	Floor Strike	Floor Strike

Br, Bz, Pl

### Door Holder and Strike - Cast



TRIMCO#	1260P
OA	1-1/2" x 1-3/4"
BHMA	L01331

Bz, Pl

### Pipe Adapter Strike - Cast

For installation where door swings over a step 3/4" IPS. (Pipe not supplied).

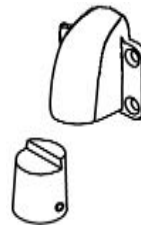

TRIMCO#	1260WP
BODY	3-1/16" x 3-1/2"

Br, Bz, Pl

### Holder with Pipe Adapter Strike - Cast

Drilled for 3/4" IPS (Pipe not supplied).

1268

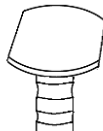

TRIMCO#	1268	1268CK
D	4"	2-3/4"
H	3-5/8"	3-5/8"

Al

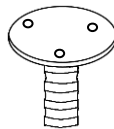

1268CK

### Plate Adapter - Cast

Sprayed to match stop. **1268** - Installed in wet cement. **1268CK** - Drilled and tapped. Requires 3" diameter cored hole in concrete. Not installed in wet cement.

C = Clearance, D = Diameter, H = Height, M = Material, OA = Overall size, P = Projection

# STOPS & HOLDERS CONT...



TRIMCO#	L1280	L1280CI
OA	3/4" x 2-1/4" x 2"	3/4" x 2-1/4" x 2"
STR	5/8" x 2-13/16"	5/8" x 2-13/16"
P	3-1/2"	3-1/2"

Br, Bz, Pl

### Door Holder-Cast

Specify fastenings.

CI= Cast Iron, sprayed to match.



TRIMCO#	1283-4S
OA	2-1/4" x 2-3/4" x 1-1/2"
STR	3" Wall
BHMA	L01301

Br, Bz, Pl

### "Adjustre" Holder Body and Wall Strike - Cast

The self-adjusting "Adjustre" compensates for door sag both horizontally and vertically.

Patent #3129024

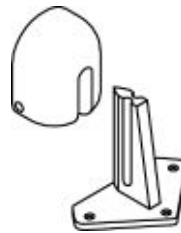

TRIMCO#	1283-2S
OA	2-1/4" x 2-3/4" x 1-1/2"
STR	3" Floor
BHMA	L01301

Br, Bz, Pl

### "Adjustre" Holder Body and Floor Strike - Cast

The self-adjusting "Adjustre" compensates for door sag both horizontally and vertically.

Patent #3129024



TRIMCO#	1283-6S
OA	2-1/4" x 2-3/4" x 1-1/2"
STR	3-1/8" x 2-7/8"

Br, Bz, Pl

### "Adjustre" Holder Body and Pivoting Wall Strike - Cast

Wall mount only.



TRIMCO#	1290
B	4-1/2"
STR	15/8" x 2-1/8"
H	4-7/8"
BHMA	L01251

Br, Bz, Pl

### Floor Stop & Holder - Cast

Heavy - duty

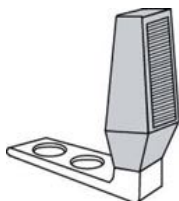

TRIMCO#	1291
H	2-1/2"
B	2-7/16" X 1"

### Angle Floor Stop

Heavy - duty  
 Supplied with wood screws and Machine screws & anchors.  
 603 finish only.



1296

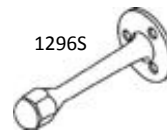

1296S

TRIMCO#	1296
B	2"
P	4-11/64"
BHMA	L02031

Br, Bz, Pl

### Base Stop - Cast

Single Hanger Bolt.

Note: Order 1296S to specify 3-hole surface mount



TRIMCO#	1298
B	2-1/4" x 2-5/8"
P	4-3/16"

Br, Bz, Pl

### Door Stop - Cast

Extra rugged, three point fastening.

B= Base, H= Height, OA= Overall Projection, STR= Strike

# WALL BUMPERS



TRIMCO#	1270CV	1270WV	1270CX	1270WX
ID	1-3/8"	1-3/8"	1-3/8"	1-3/8"
OD	2-3/16"	2-3/16"	2-3/16"	2-3/16"
P	1"	1"	1"	1"
M	Cast	Wrought	Cast	Wrought
BHMA	L02251	L02251	L02101	L02101
	Br, Bz, Pl	Br, Bz, Pl, SS	Br, Bz, Pl	Br, Bz, Pl, SS

**Wall Bumper - Combo Pack** Anti-Vandal  
 Rubber **Convex (X)** available. **Concave (V)**  
 shown. Supplied with combo pack fasteners.



1270CVPV

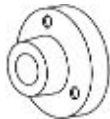

1270CVSV

**TRIMCO# 1275CVPV/1270CVSV**  
**Wall Bumper**  
 Vandal Proof. Rubber cannot  
 be removed; Anti-Rotation  
 Pin. PV=Prison Version or  
 SV=School Version  
 Also available: Cast,  
 1270CXPV or 1270CXSV

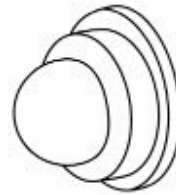

TRIMCO#	1275RP
ID	9/16"
OD	1"
P	9/16"
BHMA	L02101

Br, Bz, Pl

**Small Wall Bumper**  
 WS x RP

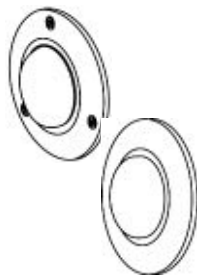

TRIMCO#	1277/79
D	4"
P	3/4"
BHMA	L02111/L02101

Br, Bz, Pl

**Large Wall Bumper - Cast**  
 Available with concealed or  
 exposed fasteners.  
**Convex (X)** only.  
 Please specify fasteners as  
 below\*

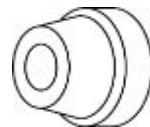

1278CV



1278CX

TRIMCO#	1278CV or 1278CX
OD	1-1/2"
P	1"
BHMA	L02101

Br, Bz, Pl, Al

**Wall Bumper**  
 WS x RP. Minimal Trim.  
 Anti-Vandal Rubber.  
**Concave (V) Convex (X)**

### Wall Bumper Abbreviations:

C = Cast	MS = Machine Screw
CP = Combo Pack	WS = Wood Screw
RP = Rawl Plug	PV = Prison Version
SV = School Version	W = Wrought
X = Convex	V = Concave
TB = Toggle Bolt	

D = Diameter, ID = Inside diameter, M = Material, OD = Outside diameter, P = Projection, T = Trim

# RESTROOM SIGNS



**TRIMCO#** 507  

---

**OA** 8" x 8"  

---

**SYM** M, BR

Restroom Sign



**TRIMCO#** 508  

---

**OA** 8"X8"  

---

**SYM** WM, BR

Restroom Sign



**TRIMCO#** 509  

---

**OA** 8" x 8"  

---

**SYM** UN, BR

Restroom Sign



**TRIMCO#** 527  

---

**OA** 8" x 8"  

---

**SYM** M, HC, BR

Restroom Sign



**TRIMCO#** 528  

---

**OA** 8" x 8"  

---

**SYM** WM, HC, BR

Restroom Sign



**TRIMCO#** 529  

---

**OA** 8" x 8"  

---

**SYM** UN, HC, BR

Restroom Sign



OA= Overall size, SYM= Symbol, M= Men, WM= Women, HC= Handicap, BR= Braille, UN= Unisex

# RESTROOM SIGNS



**TRIMCO# 751**  
OA 8" x 8" Square  
SYM Handicap

**Handicap Sign**  
 1/8" Engraved Sign.



**TRIMCO# 752**  
OA 12" Circle  
SYM Unisex

**Restroom Sign**  
 1/4" Material  
 Title 24 Signage



**TRIMCO# 753**  
OA 12" Triangle  
SYM Men

**Restroom Sign**  
 1/4" Material  
 Title 24 Signage



**TRIMCO# 754**  
OA 12" Circle  
SYM Women

**Restroom Sign**  
 1/4" Material  
 Title 24 Signage

**NOTE:** All signs are raised white letters and figures, with Braille upon request for an additional charge, on blue plastic (grade 2) and supplied with 2-sided mounting tape. Other symbols and combinations available. Please inquire.



TRIMCO#	755	756
D	2-5/8"	2-5/8"
E	Push	Pull

Br, Bz, SS

**Indicator Plate**  
 1/8" material. Adhesive mount.



TRIMCO#	757	758
OA	1-1/2" x 3-3/8"	1-1/2" x 3-3/8"
E	Push	Pull

Br, Bz, SS

**Indicator Plate**  
 1/8" material. Adhesive mount. Add "V" for vertical orientation.

OA = Overall size, SYM = Symbol, E = Engraved, D = Diameter

# SIGNAGE-ENGRAVED, DECALS & MAIL PLATES



TRIMCO#	760	793
M	1/8" Plastic Black, Red, Blue, Brown	1/8" Metal

Br, Bz, Al, SS

### Engraved Sign

Sketch required.

Specify adhesive mount or wood screw mount when ordering.

THIS DOOR TO REMAIN UNLOCKED DURING BUSINESS HOURS

THESE DOORS TO REMAIN UNLOCKED DURING BUSINESS HOURS

TRIMCO#	771	773
OA	1-1/2" x 27"	1-1/2" x 27"

### Decal Signage

**NOTE:** Decals only available in black letters on silver background.

THIS DOOR TO REMAIN UNLOCKED WHILE BUILDING IS OCCUPIED

THESE DOORS TO REMAIN UNLOCKED WHILE BUILDING IS OCCUPIED

TRIMCO#	774IBC	775IBC
OA	1-1/2" x 27"	1-1/2" x 27"

### Decal Signage

**NOTE:** Decals only available in black letters on clear background.

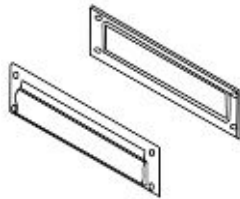

TRIMCO#	2082
OA	3-1/2" x 13"
BHMA	L06032

Br, Bz, Pl

**Mail Plate Set**  
Magazine size, spring type front plate with frame inside.

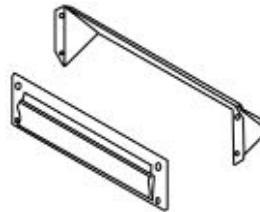

TRIMCO#	2085
OA	3-1/2" x 13"
BHMA	L06032

Br, Bz, Pl

**Mail Plate Set**  
Magazine size, spring type front plate with hood inside

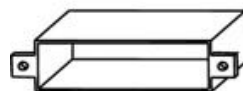

TRIMCO#	2091
OA	2-3/4" x 12-3/4" x 1-3/4"

AL

**Mail Plate Sleeve**  
For 1-3/4" door

D = Diameter, E = Engraving, M = Material, OA = Overall size

# DOOR KNOCKERS, VIEWERS & COAT HOOKS



TRIMCO#	620	621
OA	3" x 2-1/8"	6-1/8" x 3-1/8"
BHMA	L03161	L03151

Br, Pl

### Door Knocker

Engraving and viewer available.

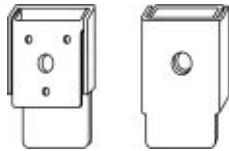

TRIMCO#	625CV	625CVE	625V	625VE
OA	3-7/8" x 2"	3-7/8" x 2"	3-1/4" x 2"	3-1/4" x 2"
Knocker	Card Holder	Card Holder	Viewer	Viewer
BHMA	L03151	L03151	L03151	L03151
	withViewer	withEng/Viewer		withEng

Br, Pl

### Door Knocker - Viewer (975)

Modern style solid metal stamping.

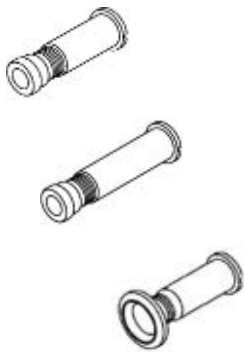

TRIMCO#	975	975L	975U	976	976U
OA	160°	160°	160°	180°	180°
BHMA	L03172	L03172	L03222	L03171	L03221

Br, Pl

### Door Viewer

Extra Long



Note: Also available - viewer with caps. Order 975U-CAP or 976U-CAP

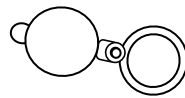

975CV (viewer cap ONLY)

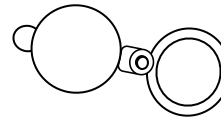

976CV (viewer cap ONLY)



TRIMCO#	3070- 1
B	1-5/8" x 1-3/8"
P	3"
H	2-1/2"
BHMA	L03111

Br, Bz, Pl

### Coat & Hat Hook - Cast

 Burnished.

TRIMCO#	3071
OA	7/8" x 5-1/2" x 1-7/8"
P	1-3/4"
M	3/16"
BHMA	L03111

Br, Bz, Pl, SS

### Coat & Hat Hook

 Attractive and rugged.

B = Base, F = Finish, OA = Overall size, P = Projection, WC = Wall to centerline, H= Height

# COAT HOOKS, HANDRAIL BRACKETS, LOCK ADAPTERS & ASTRAGALS



**TRIMCO# 3071-1**  
 OA 7/8" x 4-1/2" x 1-7/8  
 P 1-3/4"  
 M 3/16"  
 BHMA L03111  
**Coat & Hat Hook** Br, Bz, Pl, SS  
 Attractive and rugged.



**TRIMCO# 3072**  
 B 2" dia  
 P 1-3/4"  
 SHAFT 5/8" dia SS  
**Coat Hook**  
 Attractive and rugged .  
 Hanger bolt for wood doors  
 supplied. Specify for metal doors.



**TRIMCO# 3405**  
 OA 3" Base  
 P 3-1/2"  
 WC 2-1/2"  
 F Full Finish  
 BHMA L03091  
 Br, Bz, Al  
**Handrail Bracket - Cast**  
 Fits 1-3/4" diameter rail.



**TRIMCO# 3406**  
 B 3-3/4"  
 WC 3"  
 P 3-7/8"  
 BHMA L03081  
 Br, Bz, Al  
**Handrail Bracket - Cast**  
 Fits 1-3/4" diameter  
 wood rail.

**NOTE:** All of the above HANDRAILS meet ADA with narrow handrail. May require additional spacer with wide handrail.



**TRIMCO# 5000-T**  
 OA 9-1/2" x 1-7/8"  
 CTC 8-1/2"  
 Bz, Pl  
**Lock Astragal - Cast**  
 Mortise or cylindrical  
 lock. Custom spacer  
 available for longer  
 lipped strikes.



**TRIMCO# 5001**  
 OA 9-1/2"  
 CTC 6-1/2" & 8-1/2"  
 Bz, Pl  
**Lock Astragal**  
 Mortise or cylindrical  
 lock. Custom spacer  
 available for longer  
 lipped strikes.



**TRIMCO# 5002**  
 OA 6" x 1-9/16"  
 CTC 4"  
 M 13 GA SS  
**Lock Astragal**  
 Cylindrical lock only.



**TRIMCO# 5022** SS  
**Unit Lock Adapter**  
 Retrofit installation so  
 that a cylindrical lock can  
 replace a unit-lock.  
 For 1-3/4" doors only.

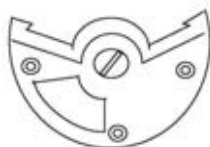

**TRIMCO# 5004**  
**Mortise Lock Indicator**  
 Red signifies Locked. Green  
 signifies Unlocked. Emergency  
 Access Available. Can be  
 customized for most locksets.



**TRIMCO# 5022A** SS  
**Unit Lock Adapter with  
 Astragal**  
 Retro-fit installation so  
 that a cylindrical lock can  
 replace a unit-lock.  
 For 1-3/4" doors only.

B = Base, F = Finish, OA = Overall size, P = Projection, WC = Wall to centerline

# GUARDS



<b>TRIMCO#</b>	<b>4015</b>
OA (plate)	3-3/8" x 1-7/16"
C	7-1/2"
HO	3/4" x 2"
BHMA	L03041

**Door Guard, Chain**  
 All Brass except chain.



Closed



Open

<b>TRIMCO#</b>	<b>4017</b>
W	1-1/2"
H	2-3/4"
P	2-13/64"

**Security Door Guard**  
 Durable die-cast construction  
 Door guard prevents door  
 from opening.



<b>TRIMCO#</b>	<b>4016</b>	<b>4016ED</b>	<b>4016-S</b>
OA	2-1/2" x 5-1/8"	1" x 1/2"	1-7/8" x 1-1/8" x specify H.
BHMA	L03041		

**Door Guard – Swing Arm**  
 Hinged bar allows guard to be  
 positioned 180° away from  
 door when not in use.  
 Optional spacers required if  
 any applied casing involved.

Adhesive mount  
 edge protector  
 for 4016



Black Nylon  
 Spacer for 4016

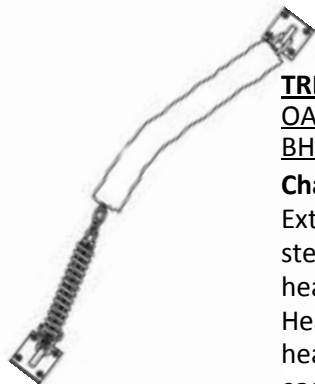

<b>TRIMCO#</b>	<b>4048</b>
OA	33-3/4"
BHMA	L02222

**Chain Crash Stop**  
 Extra heavy-duty solid welded  
 steel twist chain designed for  
 heavy commercial doors.  
 Heavily cast brass plates with  
 heavy compression springs at  
 each end. This product is  
 adjustable from 20" to 30-1/2".

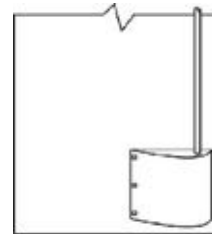

<b>TRIMCO#</b>	<b>PG8000</b>
OA	10" x 11-1/2"
P	3-3/16"

**Latch Guard - .050** Br, Bz, SS

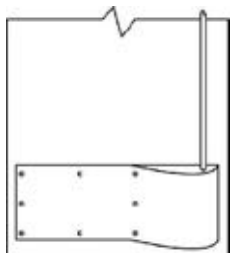

<b>TRIMCO#</b>	<b>PG8002</b>	<b>PG8002-1 (2 pieces)</b>
OA	10" x Specify	10" x Specify
P	3-3/16"	3-3/16"
L	Specify	Specify

**PG800 SERIES**  
 Latch guards prevent damage to the lower latch of exposed rod panic devices and shield  
 the foot area for the wheelchair user from the lower latch protrusion.  
**Patent# DES,350-473 & Patent# 5381627**



CTC = Center to center, M = Material, OA = Overall Size, W = Width, H = Height, C = Chain,  
 P = Projection, HO = Holder

# GUARDS & TRIM



<b>TRIMCO#</b>	<b>FG8000-XX</b>
OA	24", 36", 42"
D	1"
(XX=SIZE)	

**Frame Guard** SS  
 Protects the edges of frames from wheeled equipment. Built - in roller spins when hit.



<b>TRIMCO#</b>	<b>K39</b>
----------------	------------

**Fingerguard** – Nursery and Preschool item protects children's fingers from getting pinched between door and jamb. Up To 48", specify height when ordering. Over 48" call for quote. Maximum length is 60".



<b>TRIMCO#</b>	<b>PBT8000-1-X.710CU</b>
L	19-3/16" (30" TO 36" doors)
L	19-3/16" (37" TO 48" doors)
W	2-1/4"

X = Size SS  
**Push Bar Trim for Exit Device**  
 Bactericidal Trim cover for existing **Von Duprin 98/99**

<b>TRIMCO#</b>	<b>PBT8000-2-X.710CU</b>
L	19-3/16" (30" TO 36" doors)
L	19-3/16" (37" TO 48" doors)
W	2-1/4"

X = Size SS  
**Push Bar Trim for Exit Device**  
 Bactericidal Trim cover for existing **Stanley Apex 2000**



<b>TRIMCO#</b>	<b>PG8125VV-1</b>
Height	4-1/2"
Width	8"
Inside Height	2-1/2"
Inside depth	3"
Width	6-3/8"

**PG Series Panic Guards**



<b>TRIMCO#</b>	<b>PG8125VV-4</b>
Height	4-1/2"
Width	4"
Inside Height	2-1/2"
Inside depth	3"
Width	3-3/8"

**PG Series Panic Guards**



**PANIC GUARDS** - Protects vulnerable exit device end caps from carts, gurneys, and other potential damage.

# PLATES

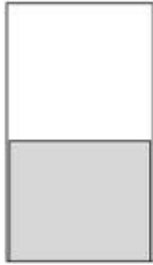

TRIMCO#	KA038	KA038-1	KA050-1	KA050-2	KA050-3
OA	18-36" H	37-48" H	17-24" H	25-42"	43-48" H
M	.038	.038	.050	.050	.050
BHMA			J101	J101	J101

Br, Bz, Al, SS

### Armor Plate

605 Finish = 24" Height maximum  
 606/609 Finishes = 36" Height maximum  
 611/612/613 Finishes = 36" Height maximum  
 Aluminum and SS = 48" Height maximum



TRIMCO#	KM038	KM038-1	KM050	KM050-1
OA	Under 6" high	4" or under	Under 6" high	4" or under
M	.038	.038	.050	.050
BHMA			J103	

SS only

Br, Bz, Al, SS

### Mop Plate

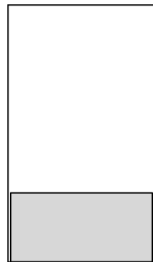

TRIMCO#	K0038	K0050
OA	7"-16" H	7"-16" H
M	.038	.050
BHMA		J102

SS only      Br, Bz, Al, S

### Kick Plate



### TRIMCO# 10x34.ILLUM.630

#### .050 Kick Plate

With self-illuminated "EXIT" sign. Meets UL924 standards.

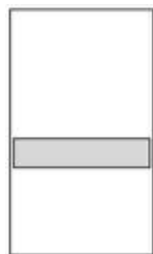

TRIMCO#	KS050
OA	6" H
M	.050

### Stretcher Plate

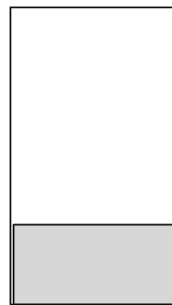

### TRIMCO# K6000

OA	4-48" high
COL	Black, Grey
M	Plastic 1/8"
BHMA	J106

Plastic

#### Kick Plate

Other colors and clear are available.

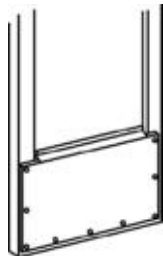

### TRIMCO# KH050

To cover glass on narrow stile aluminum doors.

**NOTE:** All Kick plates are made from solid 260 Brass, 220 Bronze, in stainless Steel or 5005H34 Aluminum. All edges are relieved. Heavy bevel at extra charge. All .038 Protection plates are Stainless Steel only. Specify countersinking if required. Available with screw or adhesive mount - specify when ordering.

COL = Color, M = Material, OA = Overall size

# EDGE GUARDS

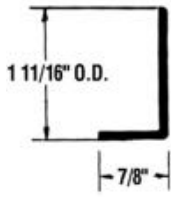

<b>TRIMCO#</b>	<b>KE31-1</b>
OA	90° x up to 42"
OD	1-11/16"
RET	7/8"
BHMA	J204

**Edge Guard** Br, Bz, SS  
For non-beveled stile on single acting door. Mortise prep shown, non-mortise available.

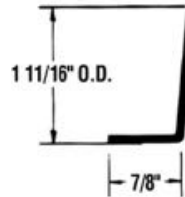

<b>TRIMCO#</b>	<b>KE32-1</b>
OA	93° x up to 42"
OD	1-11/16"
RET	7/8"
BHMA	J205

**Edge Guard** Br, Bz, SS  
For stile beveled 1/8" on single acting door. Mortise prep shown, non-mortise available.

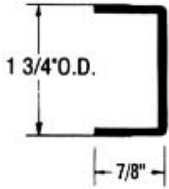

<b>TRIMCO#</b>	<b>KE33-1</b>
OA	90° x up to 42"
OD	1-3/4"
RET	7/8"
BHMA	J210

**Edge Guard** Br, Bz, SS  
For non-beveled stile on double acting door. Mortise prep shown, non-mortise available.

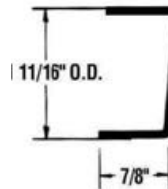

<b>TRIMCO#</b>	<b>KE33-2</b>
OA	93° x up to 42"
OD	1-3/4"
RET	7/8"
BHMA	J210

**Edge Guard** Br, Bz, SS  
Beveled Door. Specify Mortise or Non-Mortise.

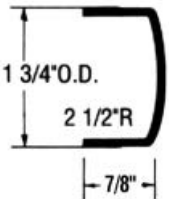

<b>TRIMCO#</b>	<b>KE34-1</b>
OA	DA x up to 42"
OD	1-3/4"
RET	7/8"
BHMA	J212

**Edge Guard** Br, Bz, SS  
Double Acting. For Radius stile on double acting mortise prep shown, non-mortise available.

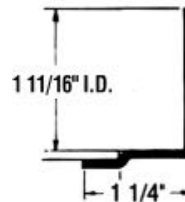

<b>TRIMCO#</b>	<b>KE35-1</b>
OA	90° x up to 42"
ID	1-11/16"
RET	1-1/4"
BHMA	J201

**Edge Guard** Br, Bz, SS  
For non-beveled stile on single acting door. Non-mortise prep shown. Mortise available.

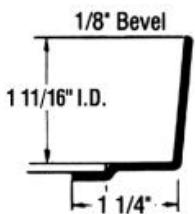

<b>TRIMCO#</b>	<b>KE36-1</b>
OA	93° x up to 42"
ID	1-11/16"
RET	1-1/4"
BHMA	J202

**Edge Guard** Br, Bz, SS  
For stile beveled 1/8" to 2" on single acting door. Non-mortise prep shown. Mortise available.

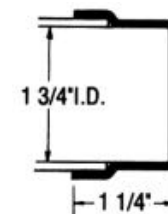

<b>TRIMCO#</b>	<b>KE37-1</b>
OA	90° x up to 42"
ID	1-3/4"
RET	1-1/4"
BHMA	J207

**Edge Guard** Br, Bz, SS  
For non-beveled stile on double acting door. Non-mortise prep shown. Mortise available.

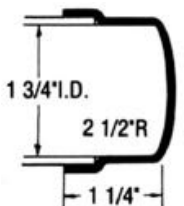

<b>TRIMCO#</b>	<b>KE38-1</b>
OA	DA x up to 42"
ID	1-3/4"
RET	1-1/4"
BHMA	J209

**Edge Guard** Br, Bz, SS  
For radius stile on double acting door. Non-Mortise prep shown. Mortise available.

**NOTE:** For angle Edge Guards, we suggest 1/16" less than door thickness. For Edge Guards, specify: Handing, Mortise, Non-Mortise, bevel, non-bevel, no cutouts.

Need drawing on all cutouts and special screw locations. Holes are drilled approximately 3/8" from edge and spaced six inches apart. Do not pre-drill doors. Include drawings for all special screw patterns, cutouts. Over 42" by quote.

Tolerance on all dimensions is +/- 1/16".

ID = Inside dimension, OA = Overall size, OD = Outside dimension, RET = Return width