

# ML2000 Series Mortise Locksets

PRODUCT CATALOG



Experience a safer  
and more open world

# Overview

## TABLE OF CONTENTS

- [ML2000 Series Overview..... 2](#)
- [ML2000 Series Features..... 3](#)
- [ML2000 Series Functions..... 4-9](#)
- [Multi-Function Configuration..... 10-11](#)
- [Motorized Electric Latch Retraction..... 12](#)
- [ML20900 Features..... 13](#)
- [ML20900 Overview..... 14-16](#)
- [ML20900 Functions..... 17-18](#)
- [ML20600 NAC with High Security Monitoring..... 19](#)
- [NAC Functions..... 20-21](#)
- [Trim Designs..... 22-41](#)
- [Muséo® Levers..... 42-54](#)
- [Vineyard™ Collection Trim..... 55-57](#)
- [Museo® Rose/Escutcheon Designs..... 58](#)
- [Behavioral Health Trim\(BHSS\)..... 59](#)
- [Behavioral Health Lever Trim \(BLSS\)..... 60](#)
- [Push/Pull Trim \(HPSK\)..... 61](#)
- [Anti-Harm Trim \(HSS\)..... 62](#)
- [Vandal Reistant Trim \(VR\)..... 63](#)
- [Indicators..... 64-69](#)
- [Options and Accessories..... 70-76](#)
- [How to Order..... 77-79](#)
- [Finishes..... 80](#)
- [Quick Codes..... 80-83](#)
- [How to Specify..... 84-86](#)
- [Reversing Handing..... 87](#)

### Quality

The ML2000 Series is a Grade 1 mortise lock designed to meet the rigors of high-traffic commercial, institutional, industrial and government applications. Constructed of heavy-gauge steel, the lockbody features our patented Quick Reversible latchbolt, and a 1" stainless steel deadbolt. A wide variety of trim designs and functions and a 10-year warranty lend to the ML2000's versatility and reliability, making it the ideal choice for use in offices, schools, hospitals, hotels and other high-use applications.

### Security

Further discourage intrusion and abuse with the ML2000VR (Vandal Resistant) series mortise lock. This lock features vandal-resistant stainless steel escutcheons with tapered edges and Torx® pin tamper resistant screws. When matched with Corbin Russwin patented high-security cylinders, any door can become a formidable barrier to intruders.

### Flexible

The ML2000 Series has a multi-function capability, allowing 12 functions to be configured from one lockbody. The ML2054 entrance function (ANSI F04) uses a universal lockbody with the ability to reconfigure into other functions without disassembling the lock case.

### Aesthetics

Complement any application with the full range of trim designs and finishes offered with ML2000 Series. From stainless steel security trims to bright brass Vineyard™ levers, design continuum can be achieved without forfeiting aesthetics. For additional information regarding designer trim, see the Corbin Russwin Vineyard™ Collection and Muséo® Collection catalogs.

### Key Advantages

- UL Cycle above and beyond test completed at 14.5 Million Cycles. Verification ID: V875753
- Patented Quick Reversible feature enables reversal of hands without disassembling the lock case (Patent pending and/or patent [www.assaabloydss.com/patents](http://www.assaabloydss.com/patents))
- Security trims provide a vandal-resistant barrier
- Can be used with new or existing Corbin Russwin key systems. Also accepts cylinders of most other manufacturers.
- Provides life safety and security in a single door prep, saving the additional cost of a deadlock
- Thru-bolted trim designs for proper alignment and increased security
- Multi-function lockbody
- Status indicator options provide peace of mind on the locked/unlocked status of a door

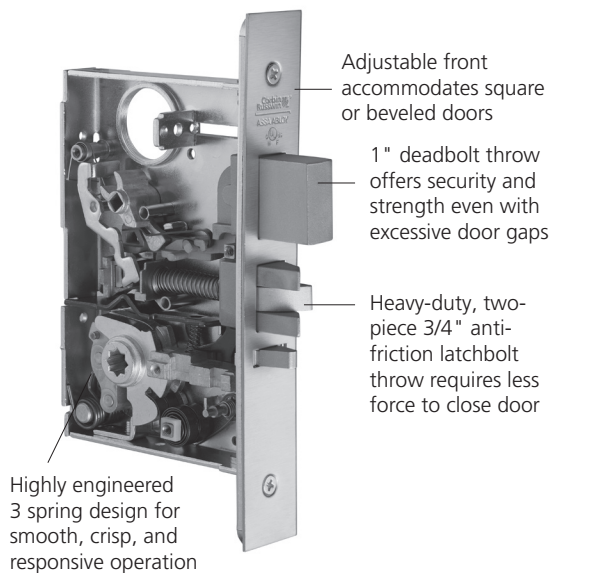

### WARNING

This product can expose you to lead which is known to the state of California to cause cancer and birth defects or other reproductive harm. For more information go to [www.P65warnings.ca.gov](http://www.P65warnings.ca.gov).

# Features

## FEATURES

### Handing

- Handed; quick reversible. The lockset can be re-handed without disassembling the lock case; see page 87.

### Door Thickness

- 1-3/4" (44mm) standard. Optional door thicknesses available; see Quick Codes, page 81.

### Backset

- 2-3/4" (70mm).

### Lockcase

- Heavy-gauge steel, 5-7/8" (149mm) x 4" (102mm) x 15/16" (24mm). Optional: non-ferrous lockcase for corrosion resistance; see Quick Codes, page 81.

### Front

- Heavy-gauge steel, 8" (203mm) x 1-1/4" (32mm) x -3/32" (2mm). Accommodates flat doors and doors beveled 1/8" (3mm) in 2" (51mm). Furnished 1-1/16" (27mm), optional D138, wide for 1-3/8" (35mm) doors.

### Armored Front

- Wrought brass, bronze or stainless steel attached by machine screws to lockcase front. ML2000VR utilizes security Torx® screws.

### Latchbolt

- 2-piece mechanical with anti-friction insert, 5/8" (16mm) x 1" (25mm) x 3/4" (19mm) throw.

### Auxiliary Latchbolt

- 9/16" (14mm) effective throw and 3/8" (10mm) effective auxiliary latch deadlocking.

### Deadbolt

- One-piece stainless steel, 19/32" (15mm) x 1-1/4" (32mm) x 1" (25mm) throw.

### Indicators

- Status indicators available in sectional or escutcheon trim with many options providing clarity of the locked/unlocked status of a door.

### Hub

- Standard knob/lever hub is steel, 5/16" (8mm)

### Spacing

- C. to c. knob/lever to cylinder: 3-5/8" (92mm).
- C. to c. knob/lever to thumbturn: 2-7/16" (62mm).

### Strike

- Wrought brass, bronze or stainless steel, ANSI straight lip standard, 4-7/8" (124mm) x 1-1/4" (32mm) x 1-1/8" (29mm) lip to center. Optional strikes, lip lengths and ANSI wrought strike box available; see Quick Codes, page 81.

### Cylinder

- Brass, 6-pin, L4 keyway, 0-bitted standard. Optional cylinders available; see Quick Codes, page 73.

### Keys

- Two nickel silver standard.

### Keying Features Available

- Master keying
- Construction master keying
- Visual key control
- Concealed key control
- Plug only to show (concealed shell)
- 7-pin cylinder
- Security cylinder
- Access 3® cylinder
- Pyramid cylinder
- Interchangeable core (LFIC or SFIC)
- Security LFIC
- Pyramid LFIC
- Access 3® LFIC
- Master ring cylinder
- Flex head cylinder

### Warranty

- Ten-year mechanical warranty.
- Five-year MELR warranty.
- Two-year electrical warranty.

## CERTIFICATION/COMPLIANCE\*

### ANSI/BHMA

- Certified A156.13 Series 1000, Operational and Security Grade 1.
- Meets A117.1 Accessibility Code.



### UL/cUL-UL10C Positive Pressure

- All locks listed for A label and lesser class doors, 4' (122cm) x 10' (305cm) single or 8' (244cm) x 10' (305cm) pair (3 hour fire door). Letter F and UL symbol on armored front indicate listing.
- Any retrofit or other field modification to a fire rated opening can potentially impact the fire rating of the opening, and Corbin Russwin, Inc. makes no representations or warranties concerning what such impact may be in any specific situation. When retrofitting any portion of an existing fire-rated opening, or specifying and installing a new fire-rated opening, please consult with a code specialist or local code official (Authority Having Jurisdiction) to ensure compliance with all applicable codes and ratings.

### UL294

Electrified functions are UL294 listed access control accessories.

### California State Reference Code













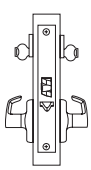

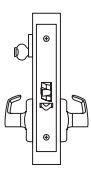
- (Formerly Title 19, California State Fire Marshal Standard)
- All levers with returns, return to within 1/2" (13mm) of door face.

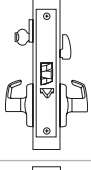
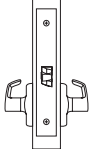
### Windstorm/Hurricane

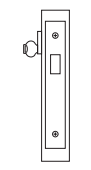

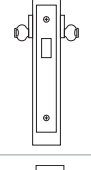
- Certified (refer to local codes).

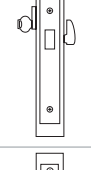
\*Any undated reference to a code or standard appearing in the this catalog shall be interpreted as referring to the latest edition of that code or standard.

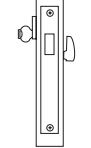
# Functions

Outside	Inside	Function (ANSI No.)	Type	Function Description
  A01		ML2002	Classroom Intruder	<ul style="list-style-type: none"> <li>Latchbolt by grip either side, unless outside grip is locked by key either side.</li> <li>Outside grip locked or unlocked by cylinder either side.</li> <li>Auxiliary latch deadlocks latchbolt.</li> <li>Inside grip always free.</li> </ul>
  A01		ML2003	Classroom	<ul style="list-style-type: none"> <li>Lock or unlock outside grip by key.</li> <li>Latchbolt by grip either side, unless outside grip is locked.</li> <li>Inside grip always free.</li> <li>Auxiliary latch deadlocks latchbolt.</li> </ul>
  A01		ML2004	Classroom	<ul style="list-style-type: none"> <li>Latchbolt by grip either side, unless outside grip is locked by key outside or thumbturn inside.</li> <li>Outside grip locked or unlocked by key or thumbturn.</li> <li>Inside grip always free.</li> <li>Auxiliary latch deadlocks latchbolt.</li> </ul>
		ML2010 (F01)	Passage or Closet	<ul style="list-style-type: none"> <li>Latchbolt by grip either side.</li> <li>Both grips always free.</li> </ul>
  A01		ML2011 (F18)	Deadlock	<ul style="list-style-type: none"> <li>Deadbolt by key outside.</li> <li>No inside operation.</li> </ul> <p><b>Note:</b> Indicators available for sectional trim only.</p>
  A01		ML2012 (F16)	Deadlock	<ul style="list-style-type: none"> <li>Deadbolt by key either side.</li> </ul> <p>Note: Indicators available for sectional trim only.</p>
  A01		ML2013 (F17)	Deadlock	<ul style="list-style-type: none"> <li>Deadbolt by key outside or by thumbturn grip inside.</li> </ul> <p>Note: Indicators available for sectional trim only.</p>
  A01		ML2017 (F29)	Classroom Deadlock	<ul style="list-style-type: none"> <li>Deadbolt by key outside.</li> <li>Thumbturn grip inside retracts deadbolt only; will not project deadbolt.</li> </ul>

 Indicator options available for both sectional and VN escutcheon trim.

 Cylinder cam required.  
 Indicates rigid grip.

\* When lever handles are furnished, both outside and inside are locked when deadbolt is projected.

# Functions

Outside	Inside	Function (ANSI No.)	Type	Function Description
		ML2020 (F02)	Privacy Bedroom or Bathroom	<ul style="list-style-type: none"> <li>Latchbolt by grip* either side, when deadbolt is retracted.</li> <li>Deadbolt by thumbturn grip inside or by emergency release tool outside.</li> <li>No simultaneous deadbolt and latch retraction.</li> <li>Non-panic release.</li> <li>Not available with M19S or M19SN.</li> </ul>
 A01		ML2022 (F14)	Store Door	<ul style="list-style-type: none"> <li>Latchbolt by grip* either side when deadbolt is retracted.</li> <li>Deadbolt by key either side.</li> <li>Latchbolt retracted by key either side.</li> <li>Non-panic release.</li> <li>No simultaneous deadbolt and latch retraction.</li> </ul>
 A01		ML2024 (F21)	Entrance or Storeroom	<ul style="list-style-type: none"> <li>Latchbolt by grip* either side when deadbolt is retracted.</li> <li>Deadbolt by key outside or by thumbturn grip inside.</li> <li>Latchbolt retracted by key outside.</li> <li>Non-panic release.</li> <li>No simultaneous deadbolt and latch retraction.</li> </ul>
 A01		ML2029 (F15)	Hotel or Motel	<ul style="list-style-type: none"> <li>Latchbolt by grip inside and by guest key or master key outside.</li> <li>Outside grip always rigid.</li> <li>Deadbolt by thumbturn grip inside or by emergency key outside.</li> <li>Inside grip simultaneously retracts latchbolt and deadbolt.</li> <li>Emergency key shuts out all other keys.</li> <li>Auxiliary latch deadlocks latchbolt.</li> </ul> <p><b>Note:</b> Indicator shows deadbolt position only.</p>
		ML2030 (F19)	Privacy Bedroom or Bathroom	<ul style="list-style-type: none"> <li>Latchbolt by grip either side unless outside grip locked by thumbturn.</li> <li>Deadbolt by thumbturn grip inside or by emergency release tool outside.</li> <li>Inside grip simultaneously retracts latchbolt and deadbolt and unlocks outside grip.</li> <li>Not available with M19S or M19SN.</li> </ul>
 A01		ML2032 (F30)	Institution or Utility	<ul style="list-style-type: none"> <li>Latchbolt by key either side.</li> <li>Both grips always rigid.</li> <li>Auxiliary latch deadlocks latchbolt.</li> </ul> <p><b>Note:</b> This function does not allow free egress and can pose a life safety hazard in event of an emergency. Installation should be in accordance with approved codes only.</p>
		ML2040	Passage with Indicator	<ul style="list-style-type: none"> <li>For doors with indicator that do not require locking</li> <li>Latchbolt retracted by grip either side at all times</li> <li>Throwing thumbturn on inside changes state of status indicator</li> <li>Rotating either grip returns indicator to previous state</li> </ul> <p><b>Note:</b> Only available with "V" series indicators. Indicator option code must be specified with this function</p>
 A01		ML2042 (F09)	Entrance or Public Restroom	<ul style="list-style-type: none"> <li>Latchbolt by grip either side, unless outside grip is locked by key from inside.</li> <li>Latchbolt by key outside when outside grip is locked.</li> <li>Auxiliary latch deadlocks latchbolt.</li> <li>Inside grip always free.</li> </ul>

Indicator options available for both sectional and VN escutcheon trim.

Cylinder cam required.   
 Indicates rigid grip.

\* When lever handles are furnished, both outside and inside are locked when deadbolt is projected.

# Functions

Outside	Inside	Function (ANSI No.)	Type	Function Description
		ML2048 (F08/F10)	Entrance or Apartment	<ul style="list-style-type: none"> <li>Latchbolt* by key outside or by grip either side, unless outside grip is locked by toggle-action stop.</li> <li>Deadbolt by key outside or by thumbturn grip inside.</li> <li>Inside grip free when deadbolt is retracted.</li> <li>Non-panic release.</li> <li>No simultaneous deadbolt and latch retraction.</li> </ul> <p><b>Note:</b> Indicator shows deadbolt position only.</p>
		ML2049	Storeroom Deadbolt	<ul style="list-style-type: none"> <li>Latchbolt and deadbolt by grip inside or by key outside.</li> <li>Inside grip simultaneously retracts deadbolt and latchbolt.</li> <li>Outside grip always rigid.</li> <li>Deadbolt thrown or retracted by key outside or thumbturn grip inside.</li> <li>Auxiliary latch deadlocks latchbolt.</li> <li>Inside grip always free.</li> </ul> <p><b>Note:</b> Indicator shows deadbolt position only.</p>
		ML2050	Half Dummy Trim	<ul style="list-style-type: none"> <li>Grip acts as pull only; no operation.</li> </ul>
		ML2051 (F04)	Entrance or Office	<ul style="list-style-type: none"> <li>Latchbolt by key when outside grip locked by toggle action stop.</li> <li>Latchbolt by grip either side, unless outside grip is locked by toggle-action stop.</li> <li>Auxiliary latch deadlocks latchbolt.</li> <li>Inside grip always free.</li> </ul>
		ML2052 (F32)	Classroom Intruder	<ul style="list-style-type: none"> <li>Latchbolt by grip either side, unless outside grip is locked by key either side.</li> <li>Latchbolt by key when outside grip locked.</li> <li>Auxiliary latch deadlocks latchbolt.</li> <li>Inside grip always free.</li> <li>Outside grip remains locked unless unlocked by key either side.</li> </ul> <p><b>Note:</b> Not available with indicator, specify ML2002.</p>
		ML2053	Entrance or Office	<ul style="list-style-type: none"> <li>Latchbolt by grip either side, unless outside grip is locked or unlocked by key or thumbturn.</li> <li>Outside grip locked or unlocked by key or thumbturn.</li> <li>Latchbolt by key when outside grip locked.</li> <li>Auxiliary latch deadlocks latchbolt.</li> <li>Inside grip always free.</li> </ul>
		ML2054 (F04)	Entrance or Office	<ul style="list-style-type: none"> <li>Latchbolt by grip either side, unless outside grip is locked.</li> <li>Outside grip locked or unlocked by thumbturn.</li> <li>Latchbolt by key when outside grip locked.</li> <li>Auxiliary latch deadlocks latchbolt.</li> <li>Inside grip always free.</li> <li>Multi-function capable, see page 10 for more info.</li> </ul>
		ML2055 (F05)	Classroom	<ul style="list-style-type: none"> <li>Latchbolt by grip either side, unless outside grip is locked by key outside</li> <li>Latchbolt by key when outside grip locked.</li> <li>Auxiliary latch deadlocks latchbolt.</li> <li>Inside grip always free.</li> <li>Outside grip remains locked unless unlocked by key.</li> </ul> <p><b>Note:</b> Not available with indicator, specify ML2003.</p>

Indicator options available for both sectional and VN escutcheon trim.

Cylinder cam required.   
 Indicates rigid grip.

\* When lever handles are furnished, both outside and inside are locked when deadbolt is projected.

# Functions

Outside	Inside	Function (ANSI No.)	Type	Function Description
		ML2056 (F06)	Classroom Holdback	<ul style="list-style-type: none"> <li>Latchbolt by grip either side, unless outside grip is locked or unlocked by key.</li> <li>Latchbolt by key outside when outside grip is locked.</li> <li>Latchbolt can be held in a retracted position by key, or released by key.</li> <li>Auxiliary latch deadlocks latchbolt.</li> <li>Inside grip always free.</li> </ul> <p><b>Note:</b> Not Listed for use in fire rated applications.</p>
		ML2057 (F07)	Storeroom or Closet	<ul style="list-style-type: none"> <li>Latchbolt by grip inside or by key outside.</li> <li>Outside grip always rigid.</li> <li>Auxiliary latch deadlocks latchbolt.</li> <li>Inside grip always free.</li> </ul>
		ML2058	Entrance or Office Holdback	<ul style="list-style-type: none"> <li>Latchbolt by grip either side, unless outside grip is locked.</li> <li>Outside grip locked or unlocked by key or thumbturn.</li> <li>Latchbolt retracted by key outside when outside grip is locked.</li> <li>Latchbolt can be held in a retracted position by key or thumbturn, or released by key or thumbturn.</li> <li>Auxiliary latch deadlocks latchbolt.</li> <li>Inside grip always free.</li> </ul> <p><b>Note:</b> Not Listed for use in fire rated applications.</p>
 		ML2059	Security Storeroom or Closet	<ul style="list-style-type: none"> <li>Latchbolt and deadbolt by grip inside or by key outside.</li> <li>Inside grip simultaneously retracts deadbolt &amp; latchbolt.</li> <li>Outside grip always rigid.</li> <li>Auxiliary latch deadlocks latchbolt.</li> <li>Inside grip always free.</li> </ul> <p><b>Note:</b> Indicator shows deadbolt position only.</p>
 		ML2060 (F22)	Privacy	<ul style="list-style-type: none"> <li>Latchbolt by grip either side, except when outside grip is locked by thumbturn inside.</li> <li>Operating inside grip, closing door or operating emergency key outside unlocks outside grip.</li> <li>Inside grip always free.</li> <li>Not available with M19S or M19SN.</li> </ul>
 		ML2062 (F33)	Intruder Deadbolt	<ul style="list-style-type: none"> <li>Latchbolt by grip either side, unless outside grip is locked by projection of deadbolt.</li> <li>Deadbolt thrown or retracted by key from either side.</li> <li>Inside grip simultaneously retracts latchbolt and deadbolt and unlocks outside grip.</li> <li>Inside grip always free.</li> </ul>
 		ML2065 (F13)	Dormitory or Entrance	<ul style="list-style-type: none"> <li>Latchbolt by grip either side unless outside grip locked by projection of deadbolt.</li> <li>Deadbolt thrown or retracted by key outside or by thumbturn grip inside.</li> <li>Inside grip simultaneously retracts latchbolt and deadbolt and unlocks outside grip.</li> <li>Inside grip always free.</li> </ul>

Indicator options available for both sectional and VN escutcheon trim.

Cylinder cam required.  
 Indicates rigid grip.

\* When lever handles are furnished, both outside and inside are locked when deadbolt is projected.

# Functions

Outside	Inside	Function (ANSI No.)	Type	Function Description
		ML2067 (F20)	Apartment or Dormitory	<ul style="list-style-type: none"> <li>Latchbolt by grip either side, unless outside grip is locked by toggle-action stop or by projection of deadbolt.</li> <li>Deadbolt thrown or retracted by key outside or by thumbturn grip inside.</li> <li>Latchbolt and deadbolt retracted by key when outside grip is locked by toggle-action stop.</li> <li>Inside grip simultaneously retracts latchbolt and deadbolt; outside grip remains locked.</li> <li>Auxiliary latch deadlocks latchbolt.</li> <li>Outside grip unlocked by toggle-action stop.</li> </ul> <p><b>Note:</b> Indicator shows deadbolt position only.</p>
		ML2068	Privacy or Apartment	<ul style="list-style-type: none"> <li>Latchbolt by grip either side, unless outside grip is locked.</li> <li>Outside grip locked or unlocked by key or thumbturn.</li> <li>Operating inside grip, closing the door or using key unlocks outside grip.</li> <li>Inside grip always free.</li> <li>Auxiliary latch deadlocks latch.</li> </ul>
		ML2069 (F26)	Institutional Privacy	<ul style="list-style-type: none"> <li>Latchbolt by grip either side, except when outside is locked by thumbturn inside.</li> <li>Operating inside grip or closing door unlocks outside grip.</li> <li>Key outside retracts latch at all times, even if thumbturn is held in locked position.</li> <li>Auxiliary latch deadlocks latchbolt.</li> <li>Not available with M19S, M19N, M19V, M19SN, M19VN.</li> </ul>
		ML2070	Full Dummy Trim	<ul style="list-style-type: none"> <li>Grips act as pulls only; no operation.</li> </ul>
		ML2072	Classroom Intruder	<ul style="list-style-type: none"> <li>Latchbolt by grip from either side unless outside grip is locked by projection of deadbolt.</li> <li>Deadbolt thrown or retracted by key from either side.</li> <li>Inside grip simultaneously retracts latchbolt and deadbolt; outside grip remains locked.</li> <li>Key either side unlocks outside grip; outside grip remains locked unless unlocked by key.</li> <li>Auxiliary latch deadlocks latchbolt.</li> </ul> <p><b>Note:</b> Indicator shows deadbolt position only.</p>
		ML2073	Classroom Security	<ul style="list-style-type: none"> <li>Latchbolt by grip from either side unless outside grip is locked by projection of deadbolt.</li> <li>Deadbolt thrown or retracted by key .</li> <li>Inside grip simultaneously retracts latchbolt and deadbolt; outside grip remains locked.</li> <li>Key unlocks outside grip; outside grip remains locked unless unlocked by key.</li> <li>Auxiliary latch deadlocks latchbolt.</li> </ul> <p><b>Note:</b> Indicator shows deadbolt position only.</p>

Indicator options available for both sectional and VN escutcheon trim.

Cylinder cam required.

Indicates rigid grip.

\* When lever handles are furnished, both outside and inside are locked when deadbolt is projected.

# Functions

Outside	Inside	Function (ANSI No.)	Type	Function Description
		ML2075	Security Entrance or Office	<ul style="list-style-type: none"> <li>Latchbolt by grip from either side unless outside grip is locked by projection of deadbolt.</li> <li>Deadbolt thrown or retracted by outside key or inside thumbturn.</li> <li>Inside grip simultaneously retracts latchbolt and deadbolt; outside grip remains locked.</li> <li>Key unlocks outside grip; outside grip remains locked unless unlocked by key.</li> <li>Auxiliary latch deadlocks latchbolt.</li> </ul> <p><b>Note:</b> Indicator shows deadbolt position only.</p>
		ML2080	Half Active Dummy Trim	<ul style="list-style-type: none"> <li>Non-latching operation.</li> <li>Grip always active; acts as push or pull only.</li> </ul> <p><b>Note:</b> Not available for doors over 2-1/4"</p>
		ML2082 (F11)	Dormitory or Exit	<ul style="list-style-type: none"> <li>Latchbolt by grip either side, unless outside grip is locked by toggle-action stop or by projection of deadbolt.</li> <li>Deadbolt thrown by key from either side.</li> <li>Deadbolt and latchbolt retracted by outside key when outside grip locked.</li> <li>Outside grip unlocked by toggle-action stop.</li> <li>Inside grip simultaneously retracts latchbolt and deadbolt; outside grip remains locked.</li> </ul> <p><b>Note:</b> Indicator shows deadbolt position only.</p>
		ML2087	Security Vestibule	<ul style="list-style-type: none"> <li>Latchbolt by grip outside, unless outside grip is locked by key outside.</li> <li>Outside grip remains locked unless unlocked by key outside.</li> <li>Latchbolt by key outside when outside grip locked.</li> <li>Latchbolt by key inside.</li> <li>Inside grip always rigid.</li> <li>Auxiliary latch deadlocks latchbolt.</li> </ul> <p><b>Notes:</b></p> <ul style="list-style-type: none"> <li>Handing must be specified, units are handed from the classroom function side of the door. This function can only be field handed for door swing i.e. LH to LHR or RH to RHR.</li> <li>Not available with L, R or V escutcheon trim.</li> <li>This function does not allow free egress when inside locked and can pose a life safety hazard in event of an emergency. Installation should be in accordance with approved codes only.</li> </ul>
		ML2090	Full Active Dummy Trim	<ul style="list-style-type: none"> <li>Non-latching operation.</li> <li>Both grips always active; acts as push or pulls only.</li> </ul>
		ML2092	Security Institution or Utility	<ul style="list-style-type: none"> <li>Latchbolt by key either side.</li> <li>Deadbolt thrown and retracted by key either side.</li> <li>Auxiliary latch deadlocks latchbolt.</li> <li>Inside and outside grips remain locked at all times.</li> </ul> <p><b>Notes:</b></p> <ul style="list-style-type: none"> <li>Indicator shows deadbolt position only.</li> <li>This function does not allow free egress and can pose a life safety hazard in event of an emergency. Installation should be in accordance with approved codes only.</li> </ul>

Indicator options available for both sectional and VN escutcheon trim.

Cylinder cam required.

Indicates rigid grip.

\* When lever handles are furnished, both outside and inside are locked when deadbolt is projected.

# Multi-Function Configuration

## MULTI-FUNCTION CAPABILITY FOR ML2000 SERIES

Corbin Russwin ML2000 Series mortise locks provide multi-function capability, allowing 12 functions to be configured using one lockbody.

The current ML2054 entrance function (ANSI F04) uses a universal lockbody with the ability to reconfigure into 11 other functions without disassembling the lock case and using few additional parts. All new and existing ML2054 function mortise locks provide this flexibility.

By specifying the ML2054, stock ordering is easier and facility maintenance is simplified.

Illustration	Function (ANSI No.)	Type	Function Description	Instructions	Additional Part(s) Required
	ML2054 (F04)	Entrance or Office	<ul style="list-style-type: none"> <li>Latchbolt by grip either side, unless outside grip is locked by thumbturn.</li> <li>Outside grip locked or unlocked by thumbturn.</li> <li>Latchbolt by key when outside grip locked.</li> <li>Auxiliary latch deadlocks latchbolt.</li> <li>Inside grip always free.</li> </ul>	<ul style="list-style-type: none"> <li>Install thumbturn on inside.</li> <li>Install cylinder with A01 cam on outside.</li> </ul>	<ul style="list-style-type: none"> <li>No additional parts required</li> </ul>
	ML2010 (F01)	Passage or Closet	<ul style="list-style-type: none"> <li>Latchbolt by grip either side.</li> <li>Both grips always free.</li> </ul> <p>*Multi-Function lockbody comes with auxiliary latchbolt, does not affect the operation of the function</p>	<ul style="list-style-type: none"> <li>Do not install thumbturn or cylinder.</li> <li>Remove red locking screw from lockbody.</li> <li>Install lock in unlocked condition.</li> </ul>	<ul style="list-style-type: none"> <li>No additional parts required</li> </ul>
	ML2032 (F30)	Institution or Utility	<ul style="list-style-type: none"> <li>Latchbolt by key either side.</li> <li>Both grips always rigid.</li> <li>Auxiliary latch deadlocks latchbolt.</li> </ul> <p>Note: This function does not allow free egress and can pose a life safety hazard in event of an emergency. Installation should be in accordance with approved codes only.</p>	<ul style="list-style-type: none"> <li>Do not install thumbturn on inside.</li> <li>Install cylinders with A01 cam on both inside and outside.</li> <li>Add second red locking screw.</li> <li>Install lock in locked condition.</li> </ul>	<ul style="list-style-type: none"> <li>Red locking screw (part number 684F067)</li> <li>Mortise cylinder with A01 cam</li> </ul>
	ML2042 (F09)	Entrance or Public Restroom	<ul style="list-style-type: none"> <li>Latchbolt by grip either side, unless outside grip is locked by key from inside.</li> <li>Latchbolt by key outside when outside grip is locked.</li> <li>Auxiliary latch deadlocks latchbolt.</li> <li>Inside grip always free.</li> </ul>	<ul style="list-style-type: none"> <li>Do not install thumbturn on inside.</li> <li>Install cylinders with A01 cam on outside and A02 cam on inside.</li> </ul>	<ul style="list-style-type: none"> <li>Mortise cylinder with A02 cam</li> </ul>
	ML2052 (F32)	Classroom Intruder	<ul style="list-style-type: none"> <li>Latchbolt by grip either side, unless outside grip is locked by key either side.</li> <li>Latchbolt by key when outside grip is locked.</li> <li>Auxiliary latch deadlocks latchbolt.</li> <li>Inside grip always free.</li> <li>Outside grip remains locked unless unlocked by key either side.</li> </ul>	<ul style="list-style-type: none"> <li>Do not install thumbturn on inside.</li> <li>Change cam on cylinder to A02.</li> <li>Install cylinders with A02 cam on both inside and outside.</li> </ul>	<ul style="list-style-type: none"> <li>A02 cam (part number 756F517)</li> <li>Mortise cylinder with A02 cam</li> </ul>
	ML2053	Entrance or Office	<ul style="list-style-type: none"> <li>Latchbolt by grip either side, unless outside grip is unlocked by key or thumbturn.</li> <li>Outside grip remains locked unless unlocked by key or thumbturn.</li> <li>Latchbolt by key when outside grip locked.</li> <li>Auxiliary latch deadlocks latchbolt.</li> <li>Inside grip always free.</li> </ul>	<ul style="list-style-type: none"> <li>Install thumbturn on inside.</li> <li>Change cam on cylinder to A02.</li> <li>Install cylinder on outside.</li> </ul>	<ul style="list-style-type: none"> <li>A02 cam (part number 756F517)</li> </ul>

# Multi-Function Configuration

Illustration	Function (ANSI No.)	Type	Function Description	Instructions	Additional Part(s) Required
	ML2055 (F05)	Classroom	<ul style="list-style-type: none"> <li>Latchbolt by grip either side, unless outside grip is locked by key outside.</li> <li>Latchbolt by key when outside grip locked.</li> <li>Auxiliary latch deadlocks latchbolt.</li> <li>Inside grip always free.</li> <li>Outside grip remains locked unless unlocked by key.</li> </ul>	<ul style="list-style-type: none"> <li>Do not install thumbturn on inside.</li> <li>Change cam on cylinder to A02.</li> <li>Install cylinder on outside.</li> </ul>	<ul style="list-style-type: none"> <li>A02 cam (part number 756F517)</li> </ul>
	ML2057 (F07)	Storeroom or Closet	<ul style="list-style-type: none"> <li>Latchbolt by grip inside or by key outside.</li> <li>Outside grip always rigid.</li> <li>Auxiliary latch deadlocks latchbolt.</li> <li>Inside grip always free.</li> </ul>	<ul style="list-style-type: none"> <li>Do not install thumbturn on inside.</li> <li>Install cylinder with A01 cam on outside.</li> <li>Install lock in locked condition.</li> </ul>	<ul style="list-style-type: none"> <li>No additional parts required</li> </ul>
	Configured thru multi-function lock only	Storeroom or Service	<ul style="list-style-type: none"> <li>Latchbolt by grip inside or by key outside.</li> <li>Auxiliary latch deadlocks latchbolt.</li> <li>Inside grip always free.</li> </ul>	<ul style="list-style-type: none"> <li>Do not install thumbturn on inside.</li> <li>Install cylinder with A01 cam on outside.</li> <li>Install 1/2 trim multi-function kit on outside.</li> </ul>	<ul style="list-style-type: none"> <li>1/2 trim multi-function kit (part number 853F958)*</li> </ul>
	Configured thru multi-function lock only (F31)	Exit Latch	<ul style="list-style-type: none"> <li>Latchbolt by grip inside.</li> <li>Auxiliary latch.</li> <li>Inside grip always free.</li> </ul>	<ul style="list-style-type: none"> <li>Do not install thumbturn on inside.</li> <li>Do not install cylinders.</li> <li>Install 1/2 trim multi-function kit on outside.</li> </ul>	<ul style="list-style-type: none"> <li>1/2 trim multi-function kit (part number 853F958)*</li> </ul>
	Configured thru multi-function lock only	Utility	<ul style="list-style-type: none"> <li>Latchbolt by key outside.</li> <li>Outside grip always rigid.</li> <li>Auxiliary latch deadlocks latchbolt.</li> </ul> <p>Note: This function does not allow free egress and can pose a life safety hazard in event of an emergency. Installation should be in accordance with approved codes only.</p>	<ul style="list-style-type: none"> <li>Do not install thumbturn on inside.</li> <li>Install cylinder with A01 cam on outside.</li> <li>Install 1/2 trim multi-function kit on inside.</li> <li>Install inside lever on outside.</li> </ul>	<ul style="list-style-type: none"> <li>1/2 trim multi-function kit (part number 853F958)*</li> </ul>
	Configured thru multi-function lock only	Closet	<ul style="list-style-type: none"> <li>Latchbolt by grip outside, unless grip is locked by key outside.</li> <li>Latchbolt by key when outside grip locked.</li> <li>Auxiliary latch deadlocks latchbolt.</li> <li>Outside grip remains locked unless unlocked by key.</li> </ul> <p>Note: This function does not allow free egress and can pose a life safety hazard in event of an emergency. Installation should be in accordance with approved codes only.</p>	<ul style="list-style-type: none"> <li>Do not install thumbturn on inside.</li> <li>Install cylinder with A02 cam on the outside.</li> <li>Install 1/2 trim multi-function kit on inside.</li> </ul>	<ul style="list-style-type: none"> <li>A02 cam (part number 756F517)</li> <li>1/2 trim multi-function kit (part number 853F958)*</li> </ul>

\*1/2 trim multi-function kit includes: M30 adapter plate (p/n 488F278), 2 retainer rings (p/n 427F078), 2 spacers (p/n 426F918), and 2 screws (p/n 814F808).

The information detailed pertains to sectional trim for standard 1-3/4" thick doors. For escutcheon trim and other applications, please contact our Technical Product Support specialists for information and details.

# Motorized Electric Latch Retraction

## ML2000 SERIES WITH MOTORIZED ELECTRIC LATCH RETRACTION

The Motorized Electric Latch Retraction (MELR) mortise lock is designed for commercial, institutional, and industrial facilities for access control of openings where code compliance, dependable operation and resistance to physical abuse is required.

This unique option brings motorized electric latch retraction to passage, storeroom or institutional function mortise locksets. The ML2000 Series MELR mortise lock is the perfect solution for push-pull conditions or handicap access and is ideal for use with automatic operators to facilitate accessibility/ADA compliance and possible hands-free access.

### Features

- Latchbolt retracts in 1/2 of a second with applied power. Removing power allows latch to be projected back to the extended position.
- Request to Exit available as an option (storeroom and passage functions only)
- No heating detectable with extended latch holdback
- Field reversible for handing
- Can be used in conjunction with any access control application using standard mortise locks
- Creates a push/pull operation that satisfies both in-swing and out-swing doors
- Access controlled via an access control system or by physical key override
- Environmentally friendly with low power requirements
- Motorized latch retraction and spring back extension provides quiet operation
- Smooth latch retraction with applied pressure of over 50lbs to the door
- Provided with Electrolynx® connectors for ease of installation
- Available with BHSS, BLSS, and HPSK behavioral health trims

### Certifications

- ANSI/BHMA A156.13 Grade 1
- ANSI/BHMA A156.25
- UL/cUL Fire Rated for 3 Hour Doors
- UL294 Listed Access Control Accessory
- Windstorm (refer to local codes)

### Electrical Specifications

- Voltage 24VDC (+10% / -15%)
- Operating current 700mA
- Hold Current 50mA

### Warranty

- Five year limited warranty on MELR



### Functions

Outside	Inside	Function	Type	Function Description
		ML2010 x MELR	Passage	<ul style="list-style-type: none"> <li>• Power off - latchbolt extended, both levers unlocked.</li> <li>• Power on - latchbolt automatically retracted.</li> <li>• Rotating either lever retracts latchbolt.</li> <li>• Request to Exit available - specify option M92*</li> </ul>
		ML2032 x MELR	Institution or Utility	<ul style="list-style-type: none"> <li>• Power off - latchbolt extended, both levers rigid/locked.</li> <li>• Power on - latchbolt automatically retracted, both levers rigid.</li> <li>• Key in cylinder either side retracts latchbolt.</li> <li>• Auxiliary latch deadlocks latchbolt.</li> </ul> <p>Note: This function does not allow free egress and can pose a life safety hazard in event of an emergency. Installation should be in accordance with approved codes only.</p>
		ML2057 x MELR	Storeroom	<ul style="list-style-type: none"> <li>• Power off - latchbolt extended, outside lever rigid/locked.</li> <li>• Power on - latchbolt automatically retracted, outside lever rigid.</li> <li>• Key in cylinder outside retracts latchbolt.</li> <li>• Rotating inside lever retracts latchbolt.</li> <li>• Auxiliary latch deadlocks latchbolt.</li> <li>• Request to Exit available - specify option M92</li> </ul>

\*Signal sent when either lever operated; there is no differentiation between outside and inside lever.

# Features

## FEATURES

### Handing

- Handed; quick reversible. The lockset can be re-handed without disassembling the lockcase.

### Door Thickness

- 1-3/4" (44mm) standard. Optional door thicknesses available; see Quick Codes, page 81.

### Backset

- 2-3/4" (70mm).

### Lockcase

- Heavy-gauge steel, 5-7/8" (149mm) x 4" (102mm) x 15/16" (24mm).

### Front

- Heavy gauge steel, 8" (203mm) x 1-1/4" (32mm) x 3/32" (2mm).
- Accommodates flat doors and doors beveled 1/8" (3mm) in 2" (51mm).

### Armored Front

- Wrought brass, bronze or stainless steel attached by machine screws to lockcase front.

### Latchbolt

- 2-piece mechanical anti-friction insert, 5/8" (16mm) x 1" (25mm) x 3/4" (19mm) throw.

### Auxiliary Latchbolt

- 9/16" (14mm) effective throw and 3/8" (10mm) effective auxiliary latch deadlocking.

### Hub

- Standard knob/lever hub is steel, 5/16" (8mm)

### Spacing

- C. to c. knob/lever to cylinder: 3-5/8" (92mm)
- C. to c. knob/lever to thumbturn: 2-7/16" (62mm).

### Strike

- Wrought brass, bronze or stainless steel ANSI straight lip standard, 4-7/8" (124mm) x 1-1/4" (32mm) x 1-1/8" (29mm) lip to center. Optional strikes, lip lengths and ANSI wrought strike box available; see Quick Codes, page 81.

### Trim

- Available with all ML2000 Series trim designs including the Vineyard™ Collection and the Muséo® Collection. See pages 22-63.

### Cylinder

- Brass, 6-pin, L4 keyway, 0-bitted standard. Optional cylinders available; see Quick Codes, page 73.

### Keys

- Two nickel silver standard.

### Warranty

- Ten-year warranty on ML2000 mortise lockset. Five-year MELR warranty. Two-year warranty on electronic components.

## ELECTRICAL SPECIFICATIONS (FAIL SAFE/FAIL SECURE)

- Current draw: 15mA @ 12V or 24V Continuous
- Peak current draw: 500mA @ 12V or 24V (Max 2 locks per 1A Power Supply)
- Monitor switch rating: 500mA Max to 24VDC

Note: Operating voltage not to exceed +/- 10%. See Quick Codes, page 82.

## ENVIRONMENTAL SPECIFICATIONS

### Operating Temperature

- -13°F (-25°C) to 151°F (66°C)

### Operating Humidity

- 5% to 95% relative humidity non-condensing

## MONITOR OPTIONS - ML2000 AND ML20900 ECL ONLY

### M91 - Latchbolt Monitor

- Latchbolt monitoring is a SPDT switch which monitors the full extension of the main latch. Note: See page 82 for available functions.

### M92 - Request to Exit Monitor

- Request to Exit monitoring is a SPDT switch which monitors the activation of the trim. (Both levers activate switch) Note: See page 83 for available functions.

## M105 - Security Monitor

- Security Monitor is two switches in series that monitors lock status (locked or unlocked) and Auxiliary Latch position.

Note: Monitoring options may only be ordered together as follows: M91xM92, M92xM105. Recommended for fail safe applications that require monitoring of the secure side when lock loses power. See page 82 for available functions.

## Monitor Options – ML20600 NAC only Internal End-of-Line Monitoring

- Monitors the line from the access control panel to the lock, eliminating the risk of undetected tampering or damage.

## PHR – Deadbolt Privacy Function

- Engaging deadbolt disables remote access control unlocking (keypad or card reader) or scheduled unlock.

## CERTIFICATION/COMPLIANCE\* ANSI/BHMA



- Certified A156.13 Series 1000, operational and security Grade 1.
- Meets A117.1 Accessibility Code.

## UL/cUL

- All locks listed for A label and lesser class doors, 4' x 10' single or 8' x 10' pair. Letter F and UL symbol on armored front indicate listing.

Any retrofit or other field modification to a fire rated opening can potentially impact the fire rating of the opening, and Corbin Russwin, Inc. makes no representations or warranties concerning what such impact may be in any specific situation. When retrofitting any portion of an existing fire-rated opening, or specifying and installing a new fire-rated opening, please consult with a code specialist or local code official (Authority Having Jurisdiction) to ensure compliance with all applicable codes and ratings.

## UL294

Electrified functions are UL294 listed access control accessories.

## California State Reference Code

(Formerly Title 19, California State Fire Marshal Standard)

- All levers with returns comply; levers return to within 1/2" of door face.

\*Any undated reference to a code or standard appearing in this catalog shall be interpreted as referring to the latest edition of that code or standard.

# Overview

## ML20900 ELECTRIFIED MORTISE LOCKS

### Simplicity

Combine simplicity and access control with the Corbin Russwin ML20900 electrically controlled mortise lock. Utilizing the proven ML2000 Series mortise lockset with the patented quick reversible latchbolt, the ML20900 provides remote locking and unlocking. The electrified lock can be installed in a standard mortise prep with slight modification by door manufacturer. The ML20900 is ideal for use where increased security is necessary at all times, such as tenant space, pharmacies, computer rooms, and high security areas.

### Security

In applications where increased security is required, look no further than the ML2000VR Vandal Resistant Trim. This cast stainless steel trim features tapered edges, double through bolts, torx-pin tamper resistant screws and the lever remains attached to the escutcheon when the spindle is broken.

### Aesthetics

Access control doesn't mean a loss of visual appeal. The Vineyard™ Collection and the Muséo® Collection feature beautifully designed levers, perfect for high-profile applications where pleasing aesthetics is a must.

### Additional Features

- Mechanical key override
- Patented Quick Reversible latchbolt (Patent pending and/or patent [www.assaabloydss.com/patents](http://www.assaabloydss.com/patents).)

### Typical Application

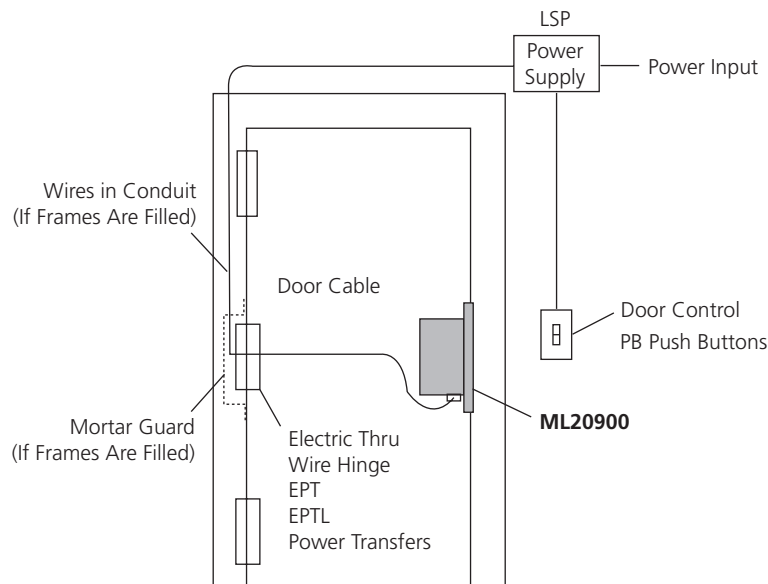

### Featuring EcoFlex®:

- Reduces energy consumption up to 92%, as certified by GreenCircle
  - Lower operating costs
  - Assists with load reduction in optimizing energy performance credit in LEED
  - Reduces number of power supplies required
- Field configurable to fail-safe or fail-secure
- Operates from 12-24VDC, offering greater flexibility in system design
- Innovative actuator design provides superior reliability
  - Higher performance and reduced maintenance
  - Ability to have longer cable runs without negatively impacting lock function
  - Reduces risk of voltage drops and eliminates inductive kickback
  - Lower total cost of ownership

Note: EcoFlex® is not available with master ring cylinders.

# Typical System Components (For Reference Only)

## TOWER STAIRWELL

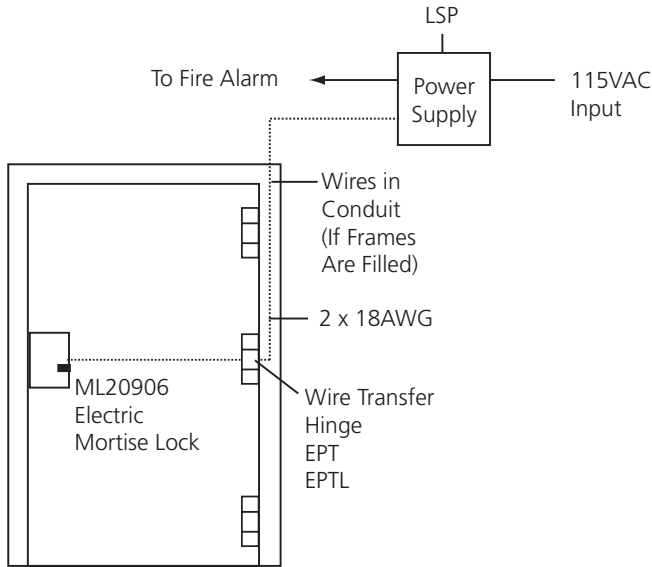

**Operation:**

Free egress at all times. Door is locked at all times preventing entry from the stairwell to a floor. Fire alarm activation will allow re-entry from the stairwell to the floor. Power failure will allow re-entry from the stairwell to the floor.

## ACCESS CONTROL ON EMPLOYEE ENTRANCE

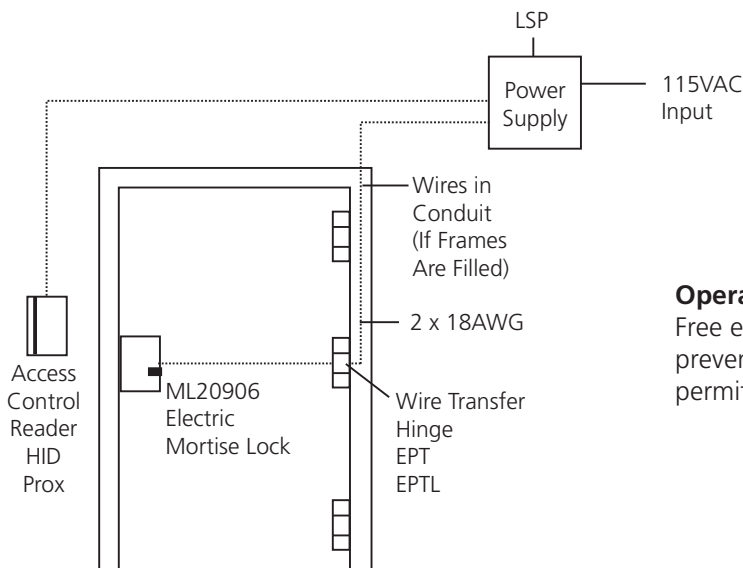

**Operation:**

Free egress at all times. Door is locked at all times preventing unauthorized entry. Authorized entry is permitted by presenting a valid user card.

# Typical System Components (For Reference Only)

## CONTROLLED ENTRY WITH ALARM

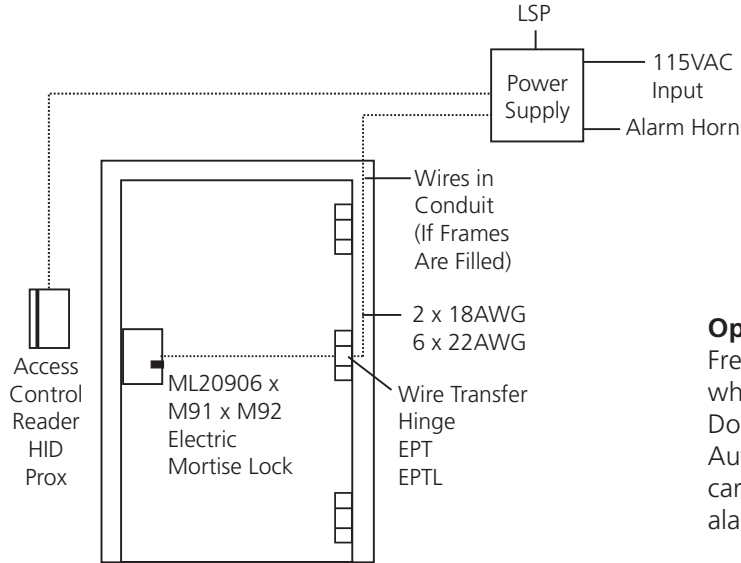

### Operation:

Free egress at all times. User exits through the door which triggers the M92 switch which shunts the alarm. Door is locked at all times preventing unauthorized entry. Authorized entry is permitted by presenting a valid user card. Forced entry will trigger M91 switch and activate alarm. Alarm is deactivated by a valid user card.

Consult factory for electrical system layouts, riser and wiring diagrams.

## LOCK SCHEMATICS

Power Leads

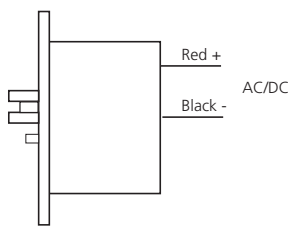

Power Leads x M92 (Request to Exit)

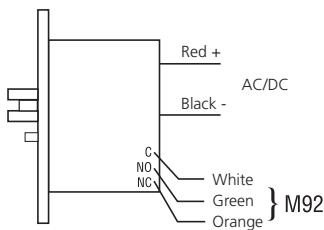

Power Leads x M91 (Latchbolt Monitor)

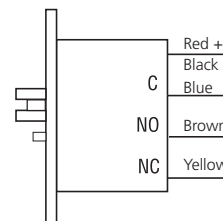

Power Leads x M105 (Security Monitor)

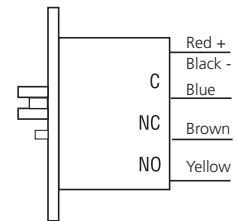



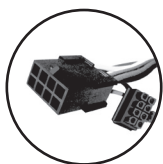



ElectroLynx®, a system of universal Molex® plug-in connectors and standardized color-coded wiring, makes installing electrified doorway components a snap!

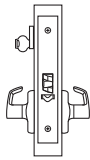
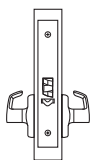

# Functions

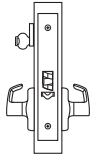
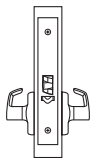
## FAIL SAFE

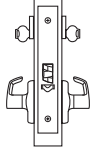
The following functions are unlocked when power is off and locked when the power is on.

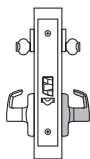





Outside	Inside	Series/Function	Description
 A01		ML20906 x SAF	<ul style="list-style-type: none"> <li>Latchbolt by grip either side, unless outside grip is locked by energizing lock.</li> <li>Latchbolt by key outside when lock is energized.</li> <li>Inside grip always free.</li> <li>Auxiliary latch deadlocks latchbolt.</li> </ul>
		ML20907 x SAF	<ul style="list-style-type: none"> <li>Latchbolt by grip either side, unless outside grip is locked by energizing lock.</li> <li>Inside grip always free.</li> <li>Auxiliary latch deadlocks latchbolt.</li> </ul>
 A01		ML20914 x SAF	<ul style="list-style-type: none"> <li>Latchbolt by grip either side, unless both grips are locked by energizing lock.</li> <li>Latchbolt by key outside when lock is energized.</li> <li>Auxiliary latch deadlocks latchbolt.</li> </ul>
		ML20915 x SAF	<ul style="list-style-type: none"> <li>Latchbolt by grip either side, unless both grips are locked by energizing lock.</li> <li>Auxiliary latch deadlocks latchbolt.</li> </ul>
 A01		ML20932 x SAF	<ul style="list-style-type: none"> <li>Latchbolt by grip either side, unless both grips are locked by energizing lock.</li> <li>Latchbolt by key inside or outside when lock is energized.</li> <li>Auxiliary latch deadlocks latchbolt.</li> </ul>
 A01		ML20987 x SAF	<ul style="list-style-type: none"> <li>Latchbolt by grip outside, unless outside grip is locked by energizing lock.</li> <li>Latchbolt by key both sides.</li> <li>Inside grip always rigid.</li> <li>Auxiliary latch deadlocks latchbolt.</li> </ul> <p><b>Notes:</b></p> <ul style="list-style-type: none"> <li>This function does not allow free egress and can pose a life safety hazard in the event of an emergency. Installation should be in accordance with approved codes only.</li> <li>Not available with L, R, or V escutcheon trim.</li> </ul>

 Indicates rigid grip.

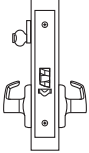
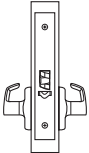
# Functions

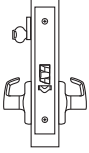
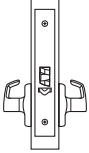
## FAIL SECURE

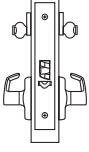
The following functions are locked when power is off and unlocked when the power is on.

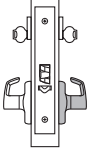
Outside	Inside	Series/Function	Description
 A01		ML20906 x SEC	<ul style="list-style-type: none"> <li>Latchbolt by grip either side only when lock is energized.</li> <li>Outside grip locked when lock is not energized.</li> <li>Latchbolt by key outside when lock is not energized.</li> <li>Inside grip always free.</li> <li>Auxiliary latch deadlocks latchbolt.</li> </ul>
		ML20907 x SEC	<ul style="list-style-type: none"> <li>Latchbolt by grip either side only when lock is energized.</li> <li>Outside grip locked when lock is not energized.</li> <li>Inside grip always free.</li> <li>Auxiliary latch deadlocks latchbolt.</li> </ul>
 A01		ML20914 x SEC	<ul style="list-style-type: none"> <li>Latchbolt by grip either side only when lock is energized.</li> <li>Both grips locked when lock is not energized.</li> <li>Latchbolt by key outside when lock is not energized.</li> <li>Auxiliary latch deadlocks latchbolt.</li> </ul>
		ML20915 x SEC	<ul style="list-style-type: none"> <li>Latchbolt by grip either side only when lock is energized.</li> <li>Both grips locked when lock is not energized.</li> <li>Auxiliary latch deadlocks latchbolt.</li> </ul>
 A01		ML20932 x SEC	<ul style="list-style-type: none"> <li>Latchbolt by grip either side only when lock is energized.</li> <li>Both grips locked when lock is not energized.</li> <li>Latchbolt by key inside or outside when lock is not energized.</li> <li>Auxiliary latch deadlocks latchbolt</li> </ul>
 A01		ML20987 x SEC	<ul style="list-style-type: none"> <li>Latchbolt by grip outside when lock is energized.</li> <li>Outside grip locked when lock is not energized.</li> <li>Latchbolt by key both sides.</li> <li>Inside grip always rigid.</li> <li>Auxiliary latch deadlocks latchbolt.</li> </ul> <p>Notes:</p> <ul style="list-style-type: none"> <li>- This function does not allow free egress and can pose a life safety hazard in the event of an emergency. Installation should be in accordance with approved codes only.</li> <li>- Not available with L, R, or V escutcheon trim.</li> </ul>

 Indicates rigid grip.

# Overview

## ML20600 NAC ELECTRIFIED MORTISE LOCK WITH HIGH SECURITY MONITORING

The high security monitoring options of our industry-leading Integrated Wiegand locks are now available in a mortise lock with ElectroLynx® connectors that can be used as a stand-alone electrified lock or in conjunction with a wall reader. Every NAC lock is shipped with door position and request to exit monitoring installed. NAC locks ordered with deadbolt are supplied with deadbolt monitoring. (PHR options will replace deadbolt monitoring with deadbolt privacy)

### HIGH SECURITY MONITORING OPTIONS

#### • Internal End-of-Line Monitoring

Integrated directly into the mortise lock, internal end-of-line resistors monitor the line from the access control panel to the lock. Typically, resistors are installed at the panel or above the door, creating vulnerability between the resistors and the locks. Incorporating resistors within the lock eliminates any risk of undetected tampering or damage, while also reducing installation costs, simplifying specifications, and offering the assurance of a factory installed and tested product.

Select a compatible resistor configuration and add the appropriate quick code to the beginning of your order string:

- **R01:** Mercury and Lenel compatible 1KΩ/2KΩ resistance supervision
- **R03:** Software House compatible 1KΩ/2KΩ resistance supervision
- **R04:** AMAG compatible 4-state supervision

#### • Deadbolt Privacy Function (PHR)

- Engaging the deadbolt disables remote access control unlocking (keypad or card reader) or scheduled unlock.
- Ideal for personal privacy areas, such as nursing rooms, on-call doctors' rooms, restrooms, and shower areas
- To order, add the PHR to the options of your order string available with SEC deadbolt functions only (ML20608 x SEC or ML20609 x SEC)



See how to order examples page 78.

#### Featuring EcoFlex®:

- Reduces energy consumption up to 92% as certified by GreenCircle
  - Lower operating costs
  - Assists with load reduction in optimizing energy performance credit in LEED
  - Reduces number of power supplies required
- Field configurable to fail-safe or fail-secure
- Operates from 12-24VDC, offering greater flexibility in system design
- Innovative actuator design provides superior reliability
  - Higher performance and reduced maintenance
  - Ability to have longer cable runs without negatively impacting lock function
  - Reduces risk of voltage drops and eliminates inductive kickback
  - Lower total cost of ownership

# Functions

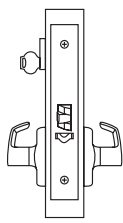
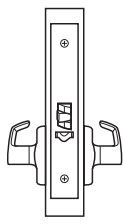

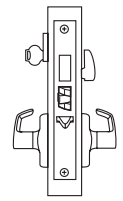
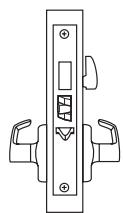

## FAIL SAFE

Outside	Inside	Series/Function	Type	Function Description
		ML20606 x NAC x SAF Fail Safe With Key Override No Deadbolt	Entry	<ul style="list-style-type: none"> <li>• Fail Safe - Power off unlocks outside trim.</li> <li>• Deadlocking latch.</li> <li>• Latch retracted by inside lever at all times.</li> <li>• Outside lever rigid except when lock is not energized.</li> <li>• Key outside retracts latch.</li> <li>• Request to exit and secure door position monitor are standard.</li> </ul>
		ML20607 x NAC x SAF Fail Safe No Key Override No Deadbolt	Entry	<ul style="list-style-type: none"> <li>• Fail Safe - Power off unlocks outside trim.</li> <li>• Deadlocking latch.</li> <li>• Latch retracted by inside lever at all times.</li> <li>• Outside lever rigid except when lock is not energized.</li> <li>• Request to exit and secure door position monitor are standard.</li> </ul>
		ML20608 x NAC x SAF Fail Safe With Key Override With Deadbolt	Entry With Deadbolt	<ul style="list-style-type: none"> <li>• Fail Safe - Power off unlocks outside trim.</li> <li>• Deadlocking latch.</li> <li>• Latch and deadbolt retracted by inside lever and deadbolt at all times.</li> <li>• Outside lever rigid except when lock is not energized.</li> <li>• Key outside projects or retracts deadbolt and retracts latch.</li> <li>• Turnpiece inside extends and retracts deadbolt.</li> <li>• Request to exit and secure door position monitor are standard.</li> </ul>
		ML20609 x NAC x SAF Fail Safe No Key Override With Deadbolt	Entry With Deadbolt	<ul style="list-style-type: none"> <li>• Fail Safe - Power off unlocks outside trim.</li> <li>• Deadlocking latch.</li> <li>• Latch and deadbolt retracted by inside lever at all times.</li> <li>• Outside lever rigid except when lock is not energized.</li> <li>• Turnpiece inside extends and retracts deadbolt.</li> <li>• Request to exit and secure door position monitor are standard.</li> </ul>

 Cylinder cam required.

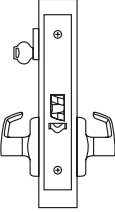
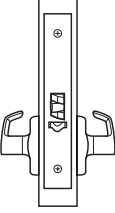
# Functions

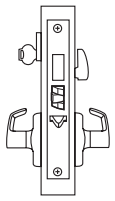
## Fail Secure

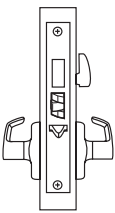
Outside	Inside	Series/Function	Type	Function Description
		ML20606 x NAC x SEC Fail Secure With Key Override No Deadbolt	Entry	<ul style="list-style-type: none"> <li>• Fail Secure - Power off, trim outside is locked.</li> <li>• Deadlocking latch.</li> <li>• Latch retracted by inside lever at all times.</li> <li>• Outside lever rigid except when lock is energized.</li> <li>• Key outside retracts latch.</li> <li>• Request to exit and secure door position monitor are standard.</li> </ul>
		ML20607 x NAC x SEC Fail Secure No Key Override No Deadbolt	Entry	<ul style="list-style-type: none"> <li>• Fail Secure - Power off, trim outside is locked.</li> <li>• Deadlocking latch.</li> <li>• Latch retracted by inside lever at all times.</li> <li>• Outside lever rigid except when lock is energized.</li> <li>• Request to exit and secure door position monitor are standard.</li> </ul>
 		ML20608 x NAC x SEC Fail Secure With Key Override With Deadbolt	Entry With Deadbolt	<ul style="list-style-type: none"> <li>• Fail Secure - Power off, trim outside is locked.</li> <li>• Deadlocking latch.</li> <li>• Latch and deadbolt retracted by inside lever and deadbolt at all times.</li> <li>• Outside lever rigid except when lock is energized.</li> <li>• Key outside projects or retracts deadbolt and retracts latch.</li> <li>• Turnpiece inside extends and retracts deadbolt.</li> <li>• Request to exit and secure door position monitor are standard.</li> <li>• Indicator shows deadbolt position only.</li> </ul> <p><b>Note:</b> Indicator only available when used with PHR option.</p>
		ML20609 x NAC x SEC Fail Secure No Key Override With Deadbolt	Entry With Deadbolt	<ul style="list-style-type: none"> <li>• Fail Secure - Power off, trim outside is locked.</li> <li>• Deadlocking latch.</li> <li>• Latch and deadbolt retracted by inside lever at all times.</li> <li>• Outside lever rigid except when lock is energized.</li> <li>• Turnpiece inside extends and retracts deadbolt.</li> <li>• Request to exit and secure door position monitor are standard.</li> <li>• Indicator shows deadbolt position only.</li> </ul> <p><b>Note:</b> Indicator only available when used with PHR option.</p>

 Indicator options available for both sectional and escutcheon trim.

 Cylinder cam required.

# Trim Designs

## LUSTRA

Complies with codes requiring lever to return to within 1/2" (13mm) of door face. Brass, bronze or stainless steel.



**LWA**  
Lever: Wrought  
Rose: Wrought

**LWB**  
Lever: Wrought  
Rose: Cast

**LSA**  
Lever: Cast  
Rose: Wrought

**LSB**  
Lever: Cast  
Rose: Cast

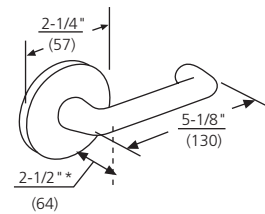

**LWF**  
Lever: Wrought  
Rose: Cast

**LSF**  
Lever: Cast  
Rose: Cast

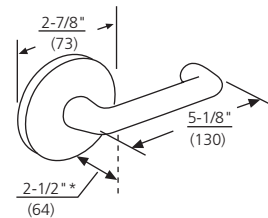

\*Dimension from face of door, not surface of rose or escutcheon.

Dimensions: inches  
                  millimeters

# Trim Designs



**LWM**  
Lever: Wrought  
Escutcheon: Wrought  
Optional: Plug only to show; master ring

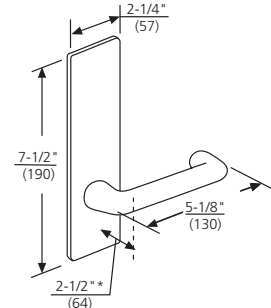

**LSM**  
Lever: Cast  
Escutcheon: Wrought  
Optional: Plug only to show; master ring



**LWN**  
Lever: Wrought  
Escutcheon: Wrought

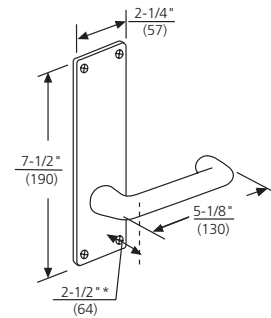

**LSN**  
Lever: Cast  
Escutcheon: Wrought



**LWP**  
Lever: Wrought  
Escutcheon: Wrought

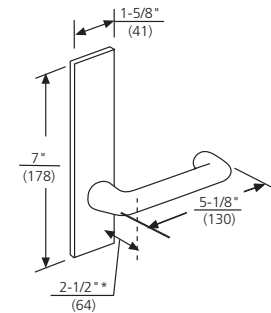

**LSP**  
Lever: Cast  
Escutcheon: Wrought  
Note: P escutcheon is not compatible with ML20900 or ML20600 NAC mortise locks



**LWR**  
Lever: Wrought  
Escutcheon: Solid stainless steel; forged brass  
Optional: Plug only to show  
Door thickness: 1-3/8" (35mm), 1-3/4" (44mm), 2-1/4" (57mm)

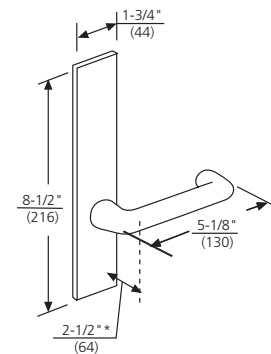

**LSR**  
Lever: Cast  
Escutcheon: Solid stainless steel, forged brass  
Optional: Plug only to show  
Door thickness: 1-3/8" (35mm), 1-3/4" (44mm), 2-1/4" (57mm)  
Note: R escutcheon is not available for functions ML2087 or ML20987

\*Dimension from face of door, not surface of rose or escutcheon.

# Trim Designs

## REGIS

Brass, bronze or stainless steel



**RWA**

Lever: Wrought  
Rose: Wrought

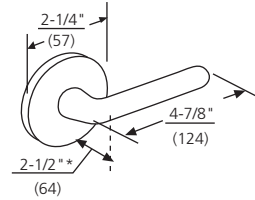

**RWB**

Lever: Wrought  
Rose: Cast

**RSA**

Lever: Cast  
Rose: Wrought

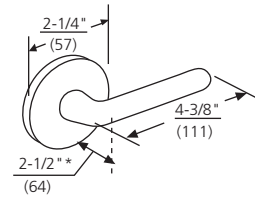

**RSB**

Lever: Cast  
Rose: Cast



**RWF**

Lever: Wrought  
Rose: Cast

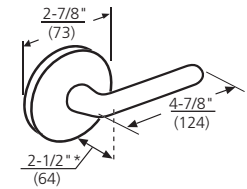

**RSF**

Lever: Cast  
Rose: Cast

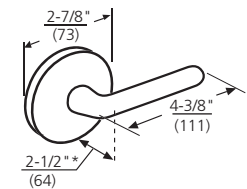

\*Dimension from face of door, not surface of rose or escutcheon.

# Trim Designs



**RWM**  
Lever: Wrought  
Escutcheon: Wrought  
Optional: Plug only to show; master ring

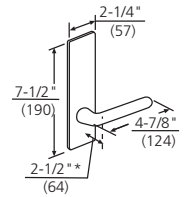

**RSM**  
Lever: Cast  
Escutcheon: Wrought  
Optional: Plug only to show; master ring

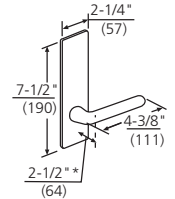

**RWN**  
Lever: Wrought  
Escutcheon: Wrought

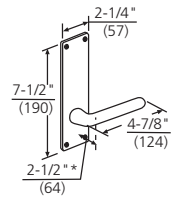

**RSN**  
Lever: Cast  
Escutcheon: Wrought

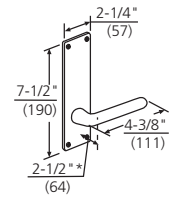

**RWP**  
Lever: Wrought  
Escutcheon: Wrought

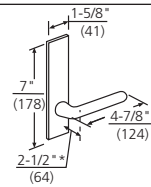

**RSP**  
Lever: Cast  
Escutcheon: Wrought  
Note: P escutcheon is not compatible with ML20900 or ML20600 NAC mortise locks

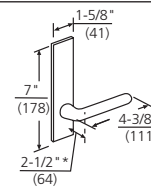

**RWR**  
Lever: Wrought  
Escutcheon: Solid stainless steel; forged brass  
Optional: Plug only to show  
Door thickness: 1-3/8" (35mm), 1-3/4" (44mm), 2-1/4" (57mm)

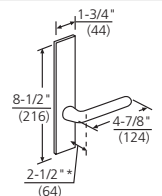

**RSR**  
Lever: Cast  
Escutcheon: Solid stainless steel; forged brass  
Optional: Plug only to show  
Door thickness: 1-3/8" (35mm), 1-3/4" (44mm), 2-1/4" (57mm)  
Note: R escutcheon is not available for functions ML2087 or ML20987

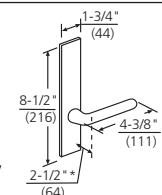

\*Dimension from face of door, not surface of rose or escutcheon.

# Trim Designs



**CITATION**

- Brass, bronze or stainless steel
- Laser engraving available



**CSA**  
Lever: Cast  
Rose: Wrought

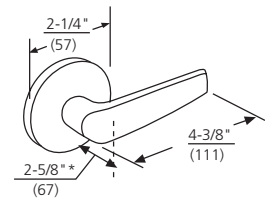

**CSB**  
Lever: Cast  
Rose: Cast



**CSF**  
Lever: Cast  
Rose: Cast

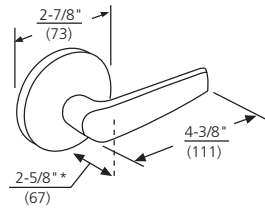

\*Dimension from face of door, not surface of rose or escutcheon.

# Trim Designs



**CSM**

- Lever: Cast  
Escutcheon: Wrought  
Optional:
- Plug only to show; master ring
  - Laser engraving on lever or escutcheon

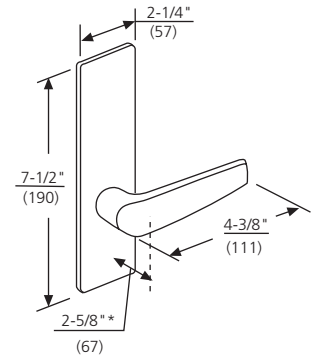

**CSN**

- Lever: Cast  
Escutcheon: Wrought  
Optional: Laser engraving on lever

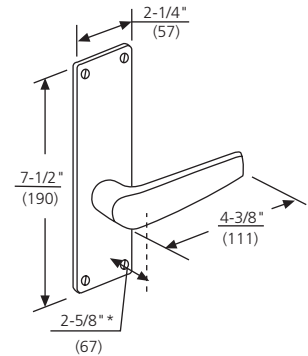

**CSP**

- Lever: Cast  
Escutcheon: Wrought  
Optional: Laser engraving on lever
- Note: P escutcheon is not compatible with ML20900 or ML20600 NAC mortise locks

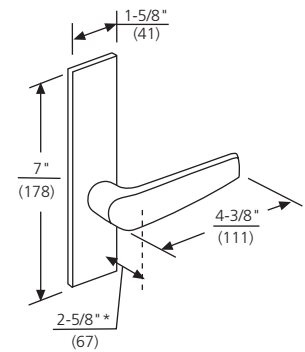

**CSR**

- Lever: Cast  
Escutcheon: Solid stainless steel; forged brass  
Optional:
- Plug only to show
  - Laser engraving on lever
- Door thickness: 1-3/8" (35mm), 1-3/4" (44mm), 2-1/4" (57mm)
- Note: R escutcheon is not available for functions ML2087 or ML20987

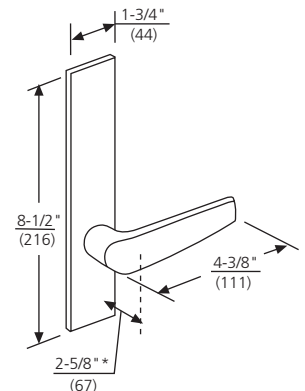

\*Dimension from face of door, not surface of rose or escutcheon.

# Trim Designs

## NEWPORT

- Complies with codes requiring lever to return to within 1/2" (13mm) of door face.
- Brass, bronze or stainless steel
- Laser engraving available



**NSA**  
Lever: Cast  
Rose: Wrought

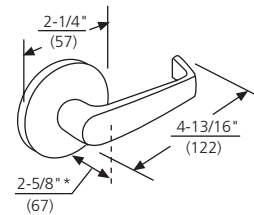

**NSF**  
Lever: Cast  
Rose: Cast

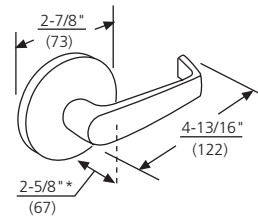

\*Dimension from face of door, not surface of rose or escutcheon.

# Trim Designs



**NSM**

- Lever: Cast  
Escutcheon: Wrought  
Optional:
- Plug only to show; master ring
  - Laser engraving on lever or escutcheon

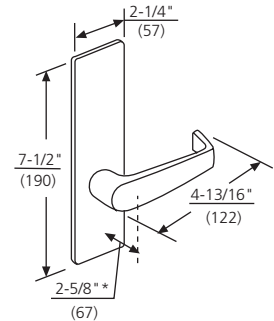

**NSN**

- Lever: Cast  
Escutcheon: Wrought  
Optional: Laser engraving on lever

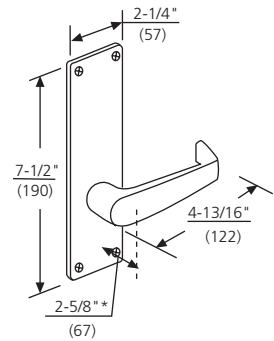

**NSP**

- Lever: Cast  
Escutcheon: Wrought  
Optional: Laser engraving on lever  
Note: P escutcheon is not compatible with ML20900 or ML20600 NAC mortise locks

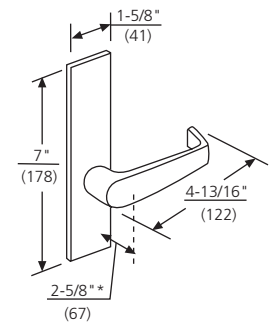

**NSR**

- Lever: Cast  
Escutcheon: Solid stainless steel; forged brass  
Optional:
- Plug only to show
  - Laser engraving on lever
- Door thickness: 1-3/8" (35mm), 1-3/4" (44mm), 2-1/4" (57mm)  
Note: R escutcheon is not available for functions ML2087 or ML20987

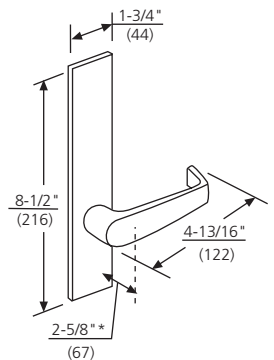

\*Dimension from face of door, not surface of rose or escutcheon.

# Trim Designs

## ARMSTRONG

- Brass, bronze or stainless steel
- Laser engraving available



### ASA

Lever: Cast  
Rose: Wrought

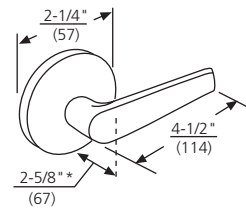

### ASB

Lever: Cast  
Rose: Cast



### ASF

Lever: Cast  
Rose: Cast

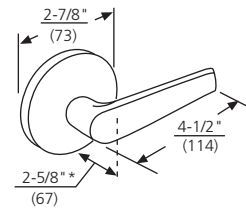

\*Dimension from face of door, not surface of rose or escutcheon.

# Trim Designs



**ASM**

- Lever: Cast  
Escutcheon: Wrought  
Optional:
- Plug only to show; master ring
  - Laser engraving on lever or escutcheon

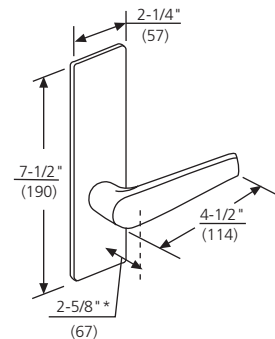

**ASN**

- Lever: Cast  
Escutcheon: Wrought  
Optional: Laser engraving on lever

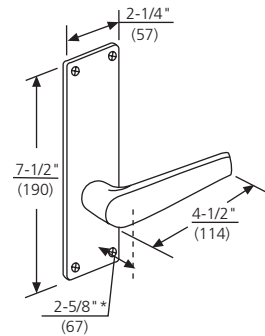

**ASP**

- Lever: Cast  
Escutcheon: Wrought  
Optional: Laser engraving on lever  
Note: P escutcheon is not compatible with ML20900 or ML20600 NAC mortise locks

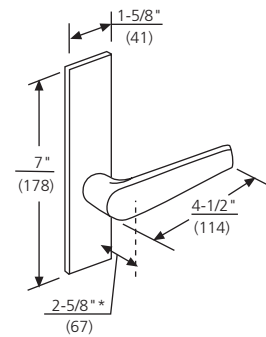

**ASR**

- Lever: Cast  
Escutcheon: Solid stainless steel; forged brass  
Optional:
- Plug only to show
  - Laser engraving on lever
- Door thickness: 1-3/8" (35mm), 1-3/4" (44mm), 2-1/4" (57mm)  
Note: R escutcheon is not available for functions ML2087 or ML20987



\*Dimension from face of door, not surface of rose or escutcheon.

# Trim Designs

## DIRKE

Brass, bronze or stainless steel

- Not reversible
- Handed levers



### DSA

Lever: Cast  
Rose: Wrought  
Specify hand

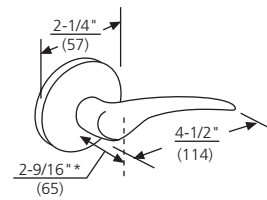

### DSB

Lever: Cast  
Rose: Cast  
Specify hand



### DSF

Lever: Cast  
Rose: Cast  
Specify hand

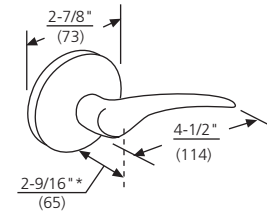

\*Dimension from face of door, not surface of rose or escutcheon.

# Trim Designs



**DSM**

Lever: Cast  
Escutcheon: Wrought  
Optional: Plug only to show; master ring  
Specify hand

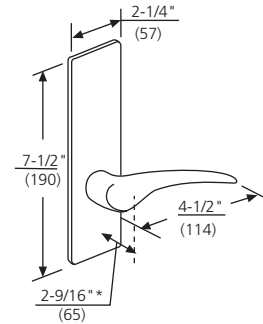

**DSN**

Lever: Cast  
Escutcheon: Wrought  
Specify hand

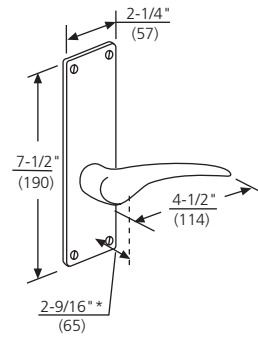

**DSP**

Lever: Cast  
Escutcheon: Wrought  
Specify hand  
Note: P escutcheon is not compatible with ML20900 or ML20600 NAC mortise locks

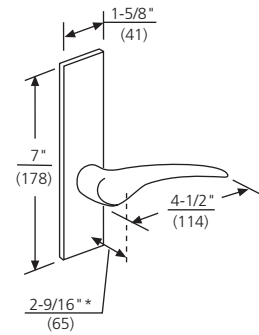

**DSR**

Lever: Cast  
Escutcheon: Solid stainless steel; forged brass  
Optional: Plug only to show  
Door thickness: 1-3/8" (35mm), 1-3/4" (44mm), 2-1/4" (57mm)  
Specify hand  
Note: R escutcheon is not available for functions ML2087 or ML20987

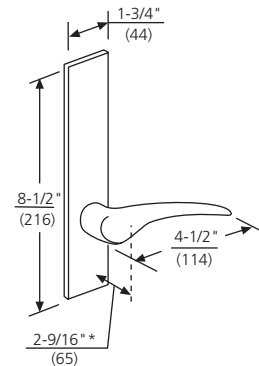

# Trim Designs

## ESSEX

Complies with codes requiring lever to return to within 1/2" (13mm) of door face.  
Brass, bronze or stainless steel



**ESA**  
Lever: Cast  
Rose: Wrought

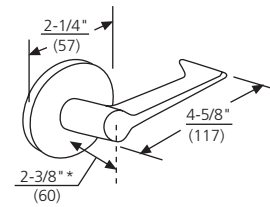

**ESB**  
Lever: Cast  
Rose: Cast

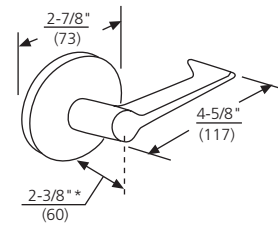

\*Dimension from face of door, not surface of rose or escutcheon.

# Trim Designs



**ESM**  
Lever: Cast  
Escutcheon: Wrought  
Optional: Plug only to show; master ring

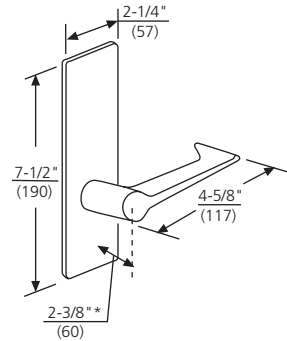

**ESN**  
Lever: Cast  
Escutcheon: Wrought

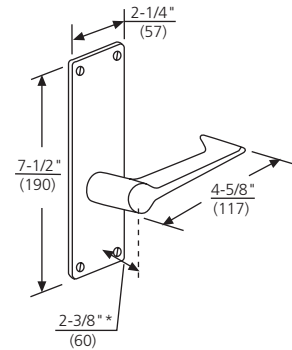

**ESP**  
Lever: Cast  
Escutcheon: Wrought  
Note: P escutcheon is not compatible with ML20900 or ML20600 NAC mortise locks

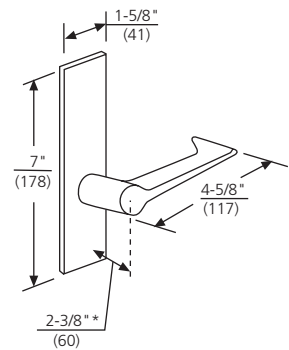

**ESR**  
Lever: Cast  
Escutcheon: Solid stainless steel; forged brass  
Optional: Plug only to show  
Door thickness: 1-3/8" (35mm), 1-3/4" (44mm), 2-1/4" (57mm)  
Note: R escutcheon is not available for functions ML2087 or ML20987

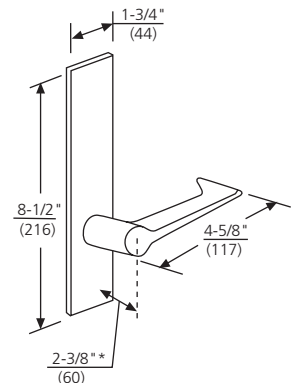

\*Dimension from face of door, not surface of rose or escutcheon.

# Trim Designs

## PRINCETON

- Complies with codes requiring lever to return to within 1/2" (13mm) of door face.
- Brass, bronze or stainless steel
- Laser engraving available



### PSA

Lever: Cast  
Rose: Wrought

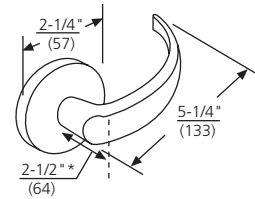

### PSB

Lever: Cast  
Rose: Cast



### PSF

Lever: Cast  
Rose: Cast

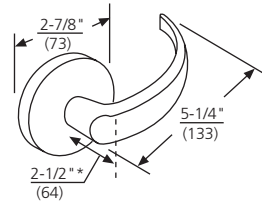

\*Dimension from face of door, not surface of rose or escutcheon.

# Trim Designs



**PSM**

- Lever: Cast
- Escutcheon: Wrought
- Optional:
  - Plug only to show; master ring
  - Laser engraving on lever or escutcheon

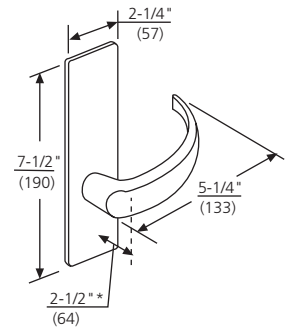

**PSN**

- Lever: Cast
- Escutcheon: Wrought
- Optional: Laser engraving on lever

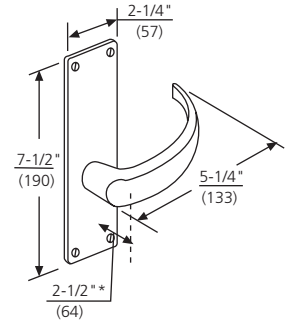

**PSP**

- Lever: Cast
- Escutcheon: Wrought
- Optional: Laser engraving on lever
- Note: P escutcheon is not compatible with ML20900 or ML20600 NAC mortise locks

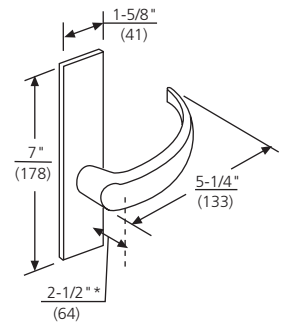

**PSR**

- Lever: Cast
- Escutcheon: Solid stainless steel; forged brass
- Optional:
  - Plug only to show
  - Laser engraving on lever
- Door thickness: 1-3/8" (35mm), 1-3/4" (44mm), 2-1/4" (57mm)
- Note: R escutcheon is not available for functions ML2087 or ML20987

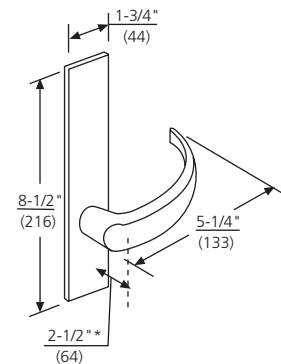

\*Dimension from face of door, not surface of rose or escutcheon.

# Trim Designs

## GLOBAL

Zinc



**GZA**  
Knob: Solid Cast  
Rose: Wrought

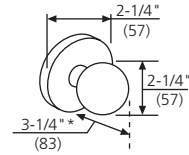

**GZB**  
Knob: Solid Cast  
Rose: Cast



**GZF**  
Knob: Solid Cast  
Rose: Cast

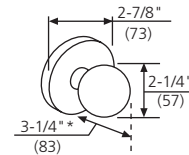

**GZH**  
Knob: Solid Cast  
Rose: Wrought

\*Dimension from face of door, not surface of rose or escutcheon.

# Trim Designs



**GZM<sup>1</sup>**  
Knob: Solid Cast  
Escutcheon: Wrought

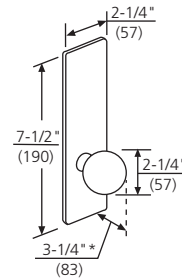

**GZN**  
Knob: Solid Cast  
Escutcheon: Wrought

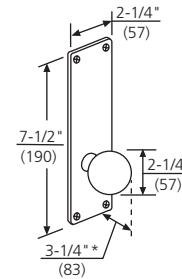

**GZP**  
Knob: Solid Cast  
Escutcheon: Wrought

Note: P escutcheon is not compatible with ML20900 or ML20600 NAC mortise locks

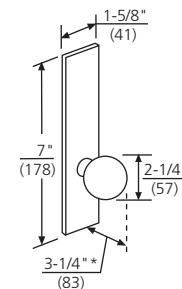

**GZR<sup>1,2</sup>**  
Knob: Solid Cast  
Escutcheon: Solid stainless steel;  
forged brass

Note: R escutcheon is not available for functions ML2087 or ML20987

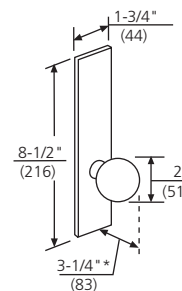

1. Optional: Plug only to show; master ring  
2. Door thickness: 1-3/8" (35mm), 1-3/4" (44mm), 2-1/4" (57mm)  
\*Dimension from face of door, not surface of rose or escutcheon.

# Trim Designs

## YANKEE

Zinc



### YZA

Knob: Solid Cast  
Rose: Wrought

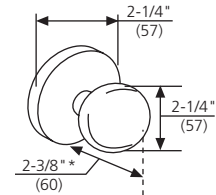

### YZB

Knob: Solid Cast  
Rose: Cast

### YZF

Knob: Solid Cast  
Rose: Cast

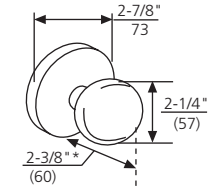

### YZH

Knob: Solid Cast  
Rose: Wrought



### YZM

Knob: Solid Cast  
Escutcheon: Wrought  
Optional: Plug only to show; master ring

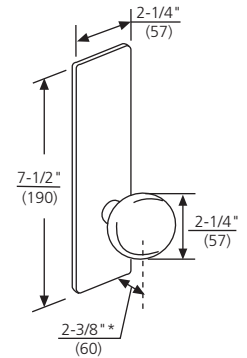

\*Dimension from face of door, not surface of rose or escutcheon.

# Trim Designs



**YZN**  
Knob: Solid Cast  
Rose: Wrought

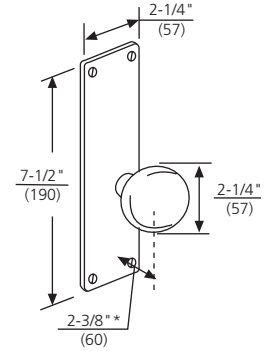

**YZP**  
Knob: Solid Cast  
Escutcheon: Wrought  
Note: P escutcheon is not compatible with ML20900 or ML20600 NAC mortise locks

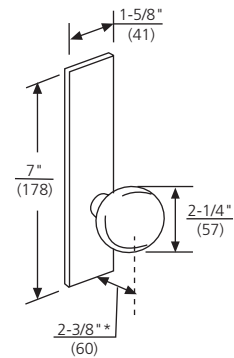

**YZR**  
Knob: Solid Cast  
Escutcheon: Solid stainless steel or forged brass  
Optional: Plug only to show  
Door thickness: 1-3/8" (35mm), 1-3/4" (44mm), 2-1/4" (57mm)  
Note: R escutcheon is not available for functions ML2087 or ML20987

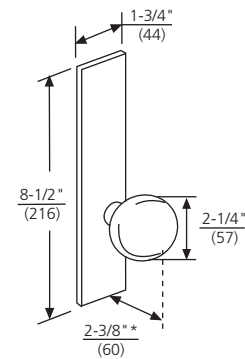

\*Dimension from face of door, not surface of rose or escutcheon.

# Muséo® Trim Designs



## GEORGIA

Timeless elegance in forms inspired by the natural world.  
Laser engraving available on 102, 103, 124 and 125.



**102**  
Lever: Cast  
Non-Handed lever

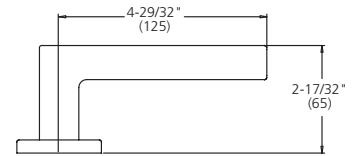

**103**  
Lever: Cast  
Non-Handed lever

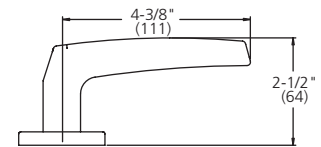

**104<sup>2</sup>**  
Lever: Cast  
Non-Handed lever

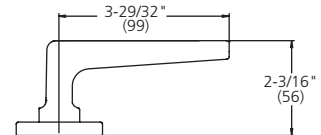

**124<sup>1</sup>**  
Lever: Cast  
Non-Handed lever

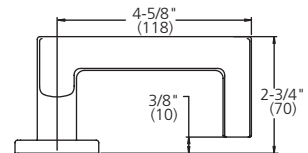

**125<sup>1</sup>**  
Lever: Cast  
Non-Handed lever

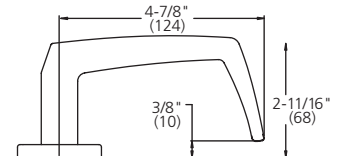

1. Complies with codes requiring lever to return to within 1/2" (13mm) of door face.
2. Not available in 629 or 630 finish

# Muséo® Trim Designs

## LASZLO

Fine art meets function through crafted lines and flowing curves



**147**  
Lever: Cast  
Non-Handed lever

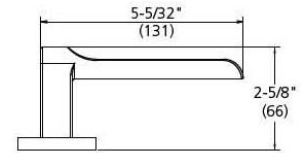

**148<sup>1</sup>**  
Lever: Cast  
Handed - Specify Hand  
Non-Reversible

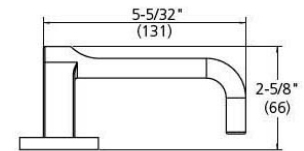

**149**  
Lever: Cast  
Non-Handed lever

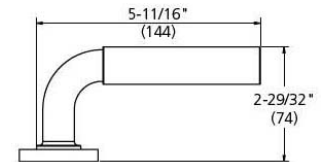

**150**  
Lever: Cast  
Non-Handed lever

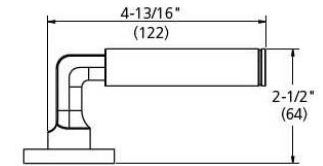

1. Complies with codes requiring lever to return to within 1/2" (13mm) of door face.

# Muséo® Trim Designs

## JACKSON

Intuitive shapes, moving with the energetic rhythm of modern life.



**105<sup>2</sup>**  
Lever: Cast  
Non-handed lever

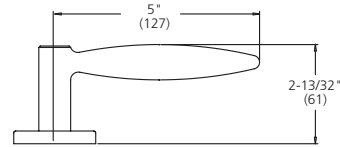

**117<sup>2</sup>**  
Lever: Cast  
Non-Handed lever

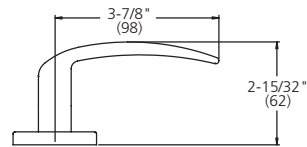

**119<sup>2</sup>**  
Lever: Cast  
Handed - Specify hand  
Non-Reversible

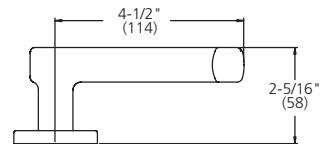

**121<sup>2</sup>**  
Lever: Cast  
Handed - Specify hand  
Non-Reversible

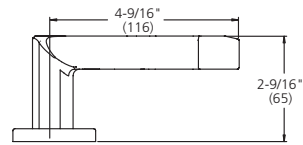

**126<sup>1,2</sup>**  
Lever: Cast  
Handed - Specify hand  
Non-Reversible

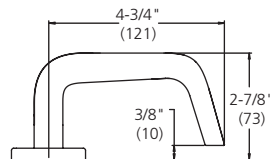

**152**  
Lever: Cast  
Non-Handed Lever

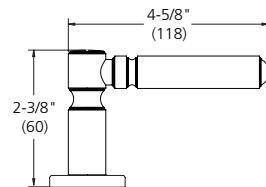

1. Complies with codes requiring lever to return to within 1/2" (13mm) of door face.  
2. Not available in 629 or 630 finish

# Muséo® Trim Designs

## SALVADOR

Dreamlike beauty manifested in solid, familiar forms.



**106**  
Lever: Cast  
Non-handed lever

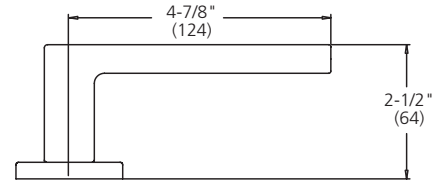

**107**  
Lever: Cast  
Non-handed lever

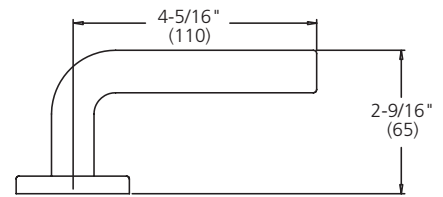

**108**  
Lever: Cast  
Non-handed lever

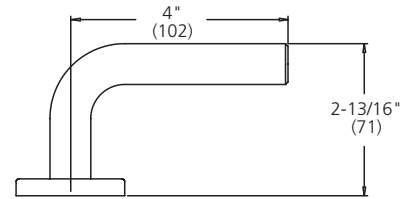

**109<sup>1</sup>**  
Lever: Cast  
Non-Handed lever

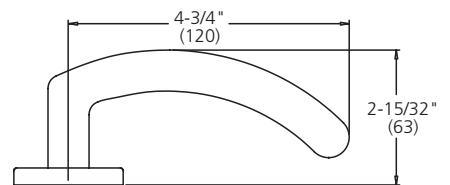

1. Complies with codes requiring lever to return to within 1/2" (13mm) of the door face

# Muséo® Trim Designs

## SALVADOR

Dreamlike beauty manifested in solid, familiar forms.



**110**  
Lever: Cast  
Non-handed lever

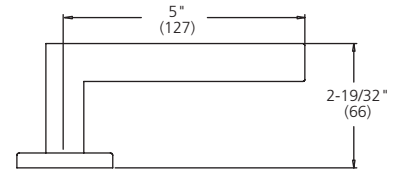

**123<sup>1</sup>**  
Lever: Cast  
Non-handed lever

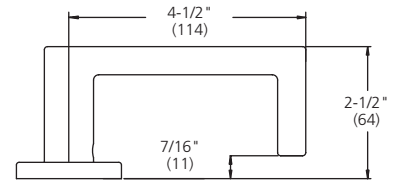

**128<sup>1</sup>**  
Lever: Cast  
Non-handed lever

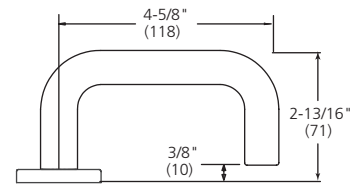

1. Complies with codes requiring lever to return to within 1/2" (13mm) of door face.

# Muséo® Trim Designs

## MARC

Fluid lyricism expressed through whimsical lines and dynamic contours.



**111<sup>1</sup>**  
Lever: Cast  
Handed - Specify hand  
Non-Reversible

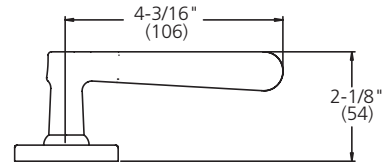

**112<sup>1</sup>**  
Lever: Cast  
Handed - Specify hand  
Non-Reversible

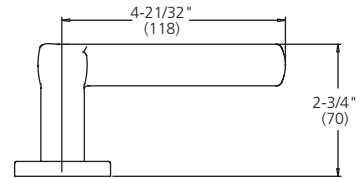

**114<sup>1</sup>**  
Lever: Cast  
Handed - Specify hand  
Non-Reversible

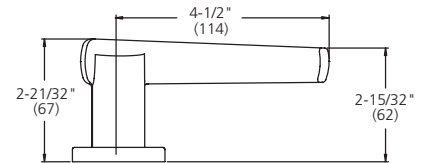

1. Not available in 629 or 630 finish

# Muséo® Trim Designs

## MARC

Fluid lyricism expressed through whimsical lines and dynamic contours.



**115<sup>2</sup>**

Lever: Cast  
Handed - Specify hand  
Non-Reversible

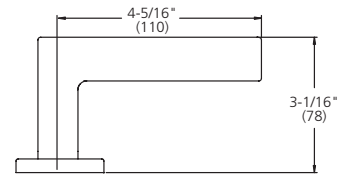

**116<sup>2</sup>**

Lever: Cast  
Handed - Specify hand  
Non-Reversible

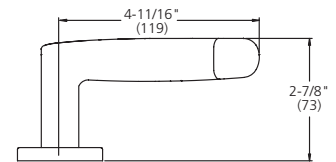

**131<sup>1,2</sup>**

Lever: Cast  
Handed - Specify hand  
Non-Reversible

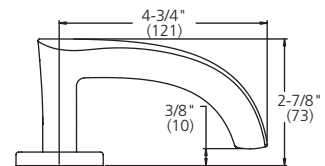

**151**

Lever: Cast  
Handed - Specify hand  
Non-Reversible

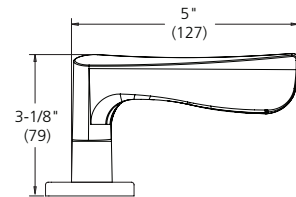

1. Complies with codes requiring lever to return to within 1/2" (13mm) of door face.
2. Not available in 629 or 630 finish

# Muséo® Trim Designs

**PIET\***

Striking levers with sleek, clean lines.



\* Refer to page 79 for how to order the Muséo® Piet Lever Collection.



**21G**  
Grooved Insert  
Lever: Cast  
Non-Handed Lever

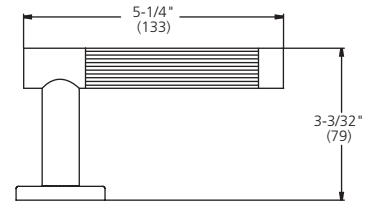

**21L**  
Leather Insert  
Lever: Cast  
Non-Handed Lever

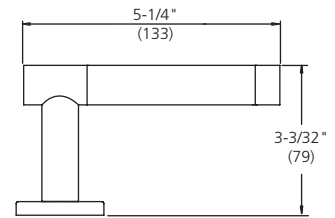

**21M**  
Polished with Satin Insert  
Lever: Cast  
Non-Handed Lever

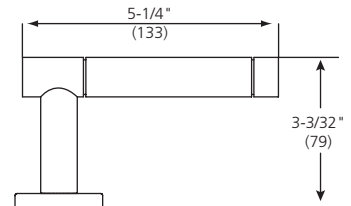

**21S**  
Santoprene™ Insert  
Lever: Cast  
Non-Handed Lever

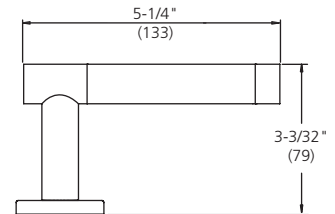

# Muséo® Trim Designs

**PIET\***

Striking levers with sleek, clean lines.



\* Refer to page 79 for how to order the Muséo® Piet Lever Collection.



**23M**  
With Raised Band  
Lever: Cast  
Non-Handed Lever

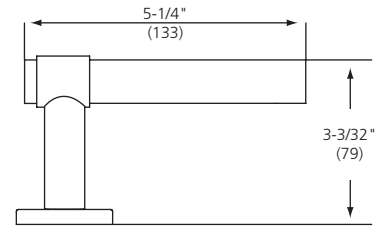

**25M**  
Plain  
Lever: Cast  
Non-Handed Lever

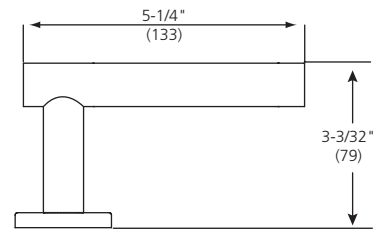

**27M**  
Plain with Two Grooves  
Lever: Cast  
Non-Handed Lever

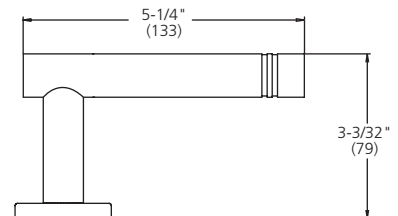

# Muséo® Trim Designs

## JOSEF

Tribute to the square with beautifully simple, but dramatic forms.



**133**  
Lever: Cast  
Non-Handed lever

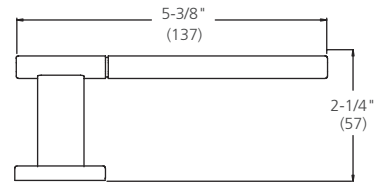

**134<sup>1</sup>**  
Lever: Cast  
Non-Handed lever

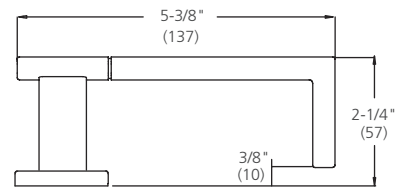

1. Complies with codes requiring lever to return to within 1/2" (13mm) of door face.

# Muséo® Trim Designs

## JOSEF<sup>2</sup>

Tribute to the square with beautifully simple, but dramatic forms.



**135**  
Lever: Cast  
Non-Handed lever

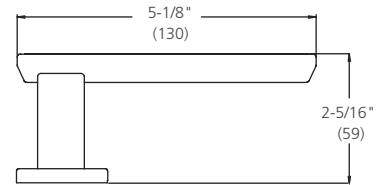

**136**  
Lever: Cast  
Non-Handed lever

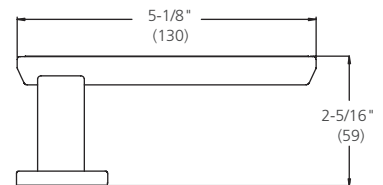

**137<sup>1</sup>**  
Lever: Cast  
Non-Handed lever

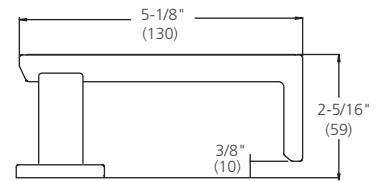

**138<sup>1</sup>**  
Lever: Cast  
Non-Handed lever

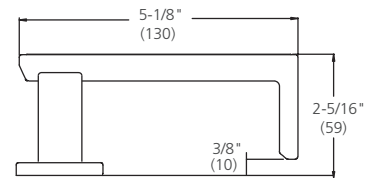

1. Complies with codes requiring lever to return to within 1/2" (13mm) of door face.
2. 135-138 contain white or black polycarbonate insert

# Muséo® Trim Designs

## GEORGES

Structural pieces that evoke an emotional response with sophisticated design.



**139**  
Lever: Cast  
Non-Handed lever



**140**  
Lever: Cast  
Handed lever

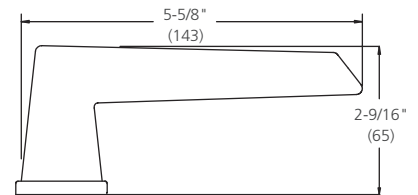

# Muséo® Trim Designs

## GEORGES

Structural pieces that evoke an emotional response with sophisticated design.



**143**  
Lever: Cast  
Non-Handed lever

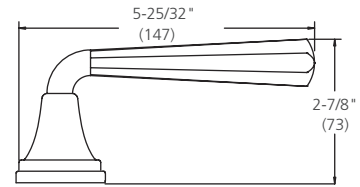

# Vineyard™ Collection Trim Designs

## MERLOT

Like its namesake, the Merlot blends with — and enhances — any decor.



**MSG**  
Lever: Cast  
Rose: Cast

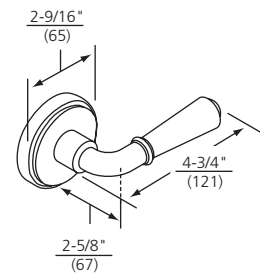

**MSL**  
Lever: Cast  
Escutcheon: Cast  
Note: L escutcheon is not available for functions ML2087 or ML20987

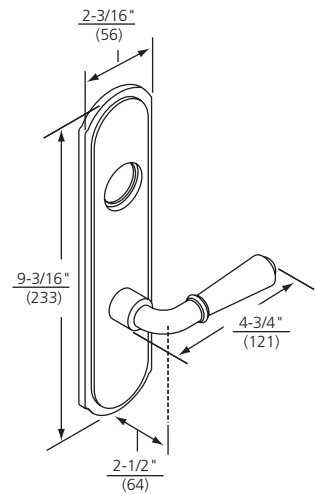

# Vineyard™ Collection Trim Designs

## ZINFANDEL

Vigorous and complex in design, the Zinfandel adds finesse to any opening.

- Handed Levers



**ZSG**  
Lever: Cast  
Rose: Cast  
Specify hand.

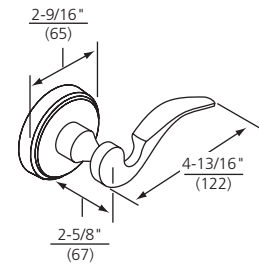

**ZSL**  
Lever: Cast  
Escutcheon: Cast  
Specify hand.  
Note: L escutcheon is not available for functions ML2087 or ML20987

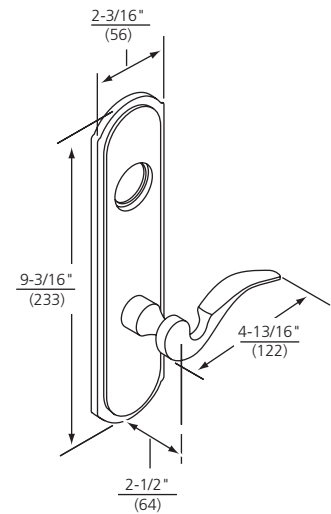

# Vineyard™ Collection Trim Designs

## FRASCATI

Fresh yet classic, the Frascati exudes the casual, timeless elegance of the Roman hills.

- Non-Reversible
- Handed Levers



**FSG**  
Lever: Cast  
Rose: Cast

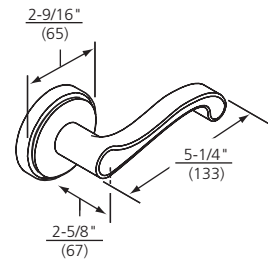

**FSL**  
Lever: Cast  
Escutcheon: Cast  
Note: L escutcheon is not available for functions ML2087 or ML20987

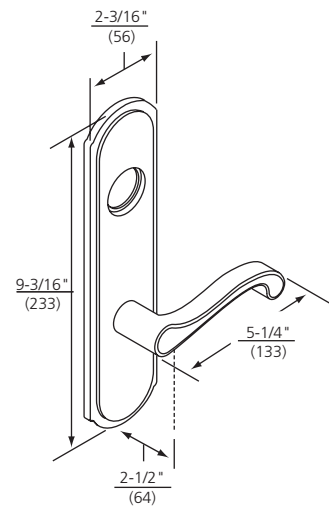

# Muséo® Trim

## MUSÉO COLLECTION ROSES<sup>1</sup> AND ESCUTCHEONS



**V Rose**  
Wrought

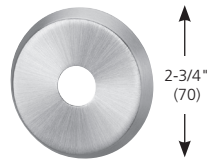

**U Rose**  
Wrought

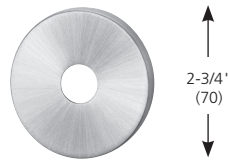

**T Rose**  
Wrought

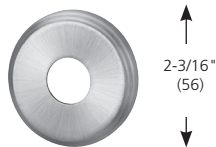

**Y Rose**  
Wrought

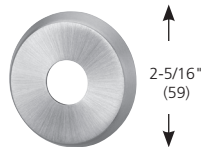

**W Rose**  
Wrought



**X Rose**  
Wrought

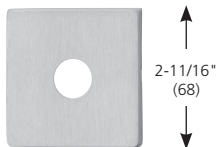

**E2 Rose<sup>2</sup>**  
Wrought

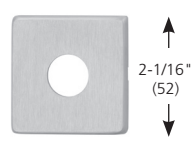

**E3 Rose<sup>2</sup>**  
Wrought

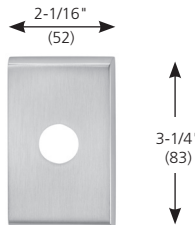

**E4 Rose<sup>2</sup>**  
Wrought



**L Escutcheon**  
Cast Brass

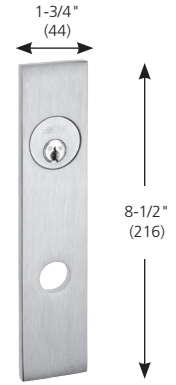

**R Escutcheon**  
Solid Stainless Steel  
or Forged Brass

## THUMBTURNS<sup>3</sup>



**MT1**



**MT2**



**MT3**

### Notes:

- Rose trims are only available with Muséo levers.
- Square cylinder collar and thumbturn backplate automatically supplied with E2, E3 and E4 roses.
- Thumbturn back plate will match shape of rose chosen (i.e. round or square).
- MT1, MT2 and MT3 are not available with M19VN indicator.
- L & R escutcheons not available with functions ML2087 or ML20987

# Behavioral Health Trim



**BHSS\***

Part of the Behavioral Health Series® of products, the ML2000 Series mortise lock with BHSS trim provides an innovative solution for behavioral health environments. The unique integrated lever and escutcheon combines aesthetics with safety. Ease of operation, along with the strength and versatility of the ML2000 Series mortise lock allows its use in many applications.

Refer to the Healthcare Hardware Catalog ([45205](#)) for more information.



**BHSS**  
Stainless Steel  
Finishes: 630, 630C

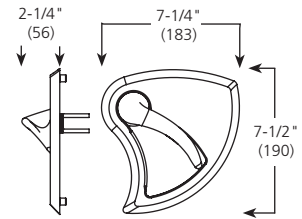

**Thumbturn**  
Stainless Steel  
Door thickness: 1-3/4" (44mm) through 2-1/4" (57mm)

(Not available with Indicator)

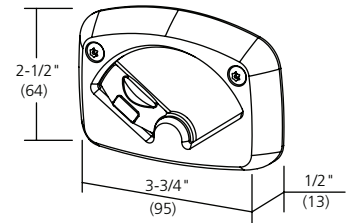

## HOW TO ORDER

**BHSS**

Quantity	Series/Function	Trim	Finish	Hand
100	ML2010	BHSS	630	RHR

\*Although these products are better designed for behavioral health applications than traditional trim, they do not eliminate the risk that an object can be affixed to, or around them. Refer to [Patient Safety Standards Guidelines](#) for the latest approved products.

# Behavioral Health Lever Trim



## BLSS\*

The BLSS trim is part of the Behavioral Health Series® of products. With an array of functions, this trim can be used on virtually any opening in healthcare applications. Sloping surfaces and overlapping rose and lever address safety concerns common in behavioral health. Optimal for tough environments, the ML2000 Series mortise lock provides impressive strength and reliability.

Refer to the Healthcare Hardware Catalog ([45205](#)) for more information.



## BLSS

Stainless Steel  
Finishes: 630, 630C

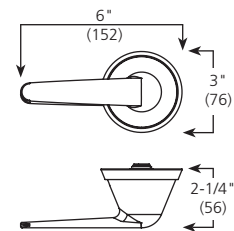

## Thumbturn

Stainless Steel  
Door thickness: 1-3/4" (44mm)  
through 2-1/4" (57mm)

(Not available with Indicator)

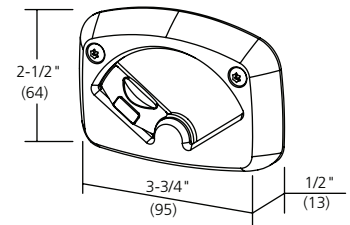

## HOW TO ORDER

### BLSS

Quantity	Series/Function	Trim	Finish	Hand
100	ML2010	BLSS	630	RHR

\*Although these products are a better design for behavioral health applications than traditional trim, they do not eliminate the risk that an object can be affixed to, or around them. Refer to [Patient Safety Standards Guidelines](#) for the latest approved products.

# Push/Pull Trim



## HPSK

The ML2000 Series mortise lock with push/pull paddle trim provides an aesthetically pleasing alternative to products with standard push/pull trim. Its heavy-duty design and ANSI/BHMA Grade1 strength help it to withstand abuse from rigorous environments. Multiple mounting orientations, hands free operation and a sleek, aesthetic form, make the ML2000 Series mortise lock ideal for use in healthcare facilities and educational facilities.

Refer to the Healthcare Catalog ([45205](#)) for more information.



## HPSK

Covers: Cast stainless steel  
Paddles: Cast stainless steel  
Specify hand.  
Finishes: 630, 630C  
"PUSH & PULL" Identification available,  
Quick Code M38.

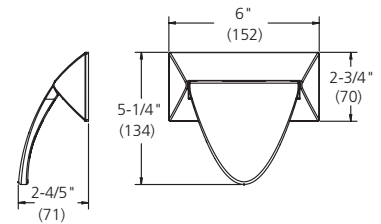

## Thumbturn

Stainless steel  
Door thickness: 1-3/4" (44mm)

(Not available with Indicator)

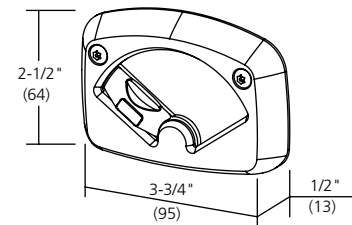

## Laser Engraving

Stainless steel  
Offered on all 3 paddle orientations  
2-1/2" w x 2-1/2" h max laser engraving area

## HOW TO ORDER

### HPSK Push/Pull\*

Quantity	Series/Function	Trim	Finish	Hand
100	ML2010	HPSK	630	RHR

\*Available on 1-3/4" door thickness only

# Anti-Harm Trim



## ANTI-HARM KNOB HSS\*

The anti-harm knob is designed for safety and security by eliminating catch points with a tapered knob recessed into the rose, a tapered thumbturn (for mortise lock thumbturn functions) with Torx® pin security screws, tapered cylinder collars and concealed mounting screws. Available as sectional trim, the anti-harm knob features recessed finger holes for a better grip and the reliability of the ML2000 Series ANSI/ BHMA grade 1 mortise lock. Ideal for psychiatric or detention facilities.

Refer to the Healthcare Hardware Catalog ([45205](#)) for more information.



### Anti-Harm Knob HSS Brass

Knob: Brass  
Door thickness: 1-3/4" (44mm) through 4" (102mm)  
in 1/4" increments.  
Finishes: 630, 630C

Notes: On lever trim x HSS Knob, the outside lever will be retained with a set screw.  
HSS Knob is only available with the rose shown. No optional roses or escutcheons.  
Knob and rose are nickel plated to match stainless steel.

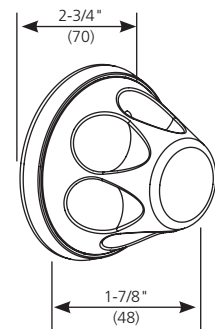

### Thumbturn Standard for all ML2000 x HSS thumb- turn functions

(Not available with Indicator)

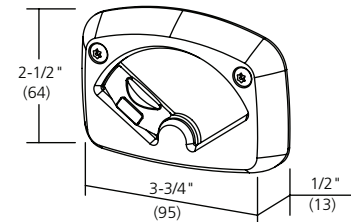

## HOW TO ORDER

### Anti-Harm Knob (HSS) Trim – HSS Knob x HSS Knob

Quantity	Series/Function	Trim	Finish	Hand
6	ML2032	HSS	630^	RH

### Anti-Harm Knob (HSS) Trim – Lever Trim x HSS Knob

Quantity	Series/Function	Trim		Finish	Hand
		Outside	Inside		
6	ML2055	NSA	HSS	630C^	RH

\*Although these products are a better design for behavioral health applications than traditional trim, they do not eliminate the risk that an object can be affixed to, or around them. Refer to [Patient Safety Standards Guidelines](#) for the latest approved products.

^619 finish provided to match 630 finish

# Vandal Resistant Trim

## ML2000VR SERIES VANDAL-RESISTANT MORTISE TRIM

### Applications

Designed for high-traffic commercial, industrial, institutional and government buildings that require a greater degree of security and vandal resistance not found on other mortise trims. Applications may include:

- Schools and universities
- Computer rooms
- Hospital pharmacies
- Banks
- Storage facilities
- Government installations
- Prisons and detention facilities
- Evidence rooms
- Weapons storage
- Compatible with all ML2000, ML20900 and ML20600 x NAC functions except the following: ML2050, ML2070, ML2080, ML2087, ML20987

### Advantages

- Flush-mounted conventional fixed core cylinder
- Cast escutcheons and levers; double through-bolted
- Torx® pin tamper resistant security screws
- Armored front to protect against tampering
- Free-floating spindle self-adjusts for door thicknesses from 1-3/4" to 2-1/4"
- Levers remain attached if spindle is broken



### NEWPORT

#### NSV

Lever: Cast stainless steel

Escutcheon: Cast stainless steel

Door thickness: 1-3/4" (44mm) standard, 2" (51mm) specify D200, 2-1/4" (57mm) specify D214

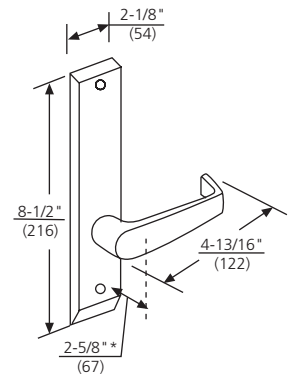

### CITATION

#### CSV

Lever: Cast stainless steel

Escutcheon: Cast stainless steel

Door thickness: 1-3/4" (44mm) standard, 2" (51mm) specify D200, 2-1/4" (57mm) specify D214

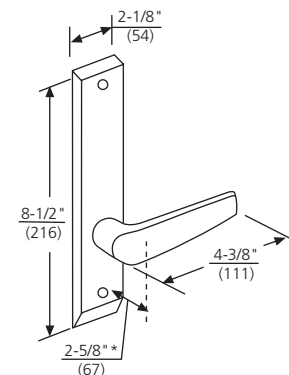

Note: only available in 630 (US32D) finish.

# Indicators

ML2000 Series indicators can be used in a variety of applications and are most commonly used to identify occupancy or display the locked/unlocked status of a room.

- Restrooms
- Quiet rooms
- Nursing mother's rooms
- Classroom doors

## FEATURES

- Inside, outside or both sides of the door
- Sectional or escutcheon trim
- Available with 29 different functions – including thumbturn functions
- Viewing window 25% larger than competition
- Patented curved design for viewing at multiple angles
- Window located prominently above the cylinder
- Highly reflective viewing window for increased safety
- Optional directional engraving available – must specify handing
- Retrofittable for existing applications

NOTE: Optional directional arrow engraving available – must specify handing. See page 68.



## FUNCTIONS

Indicators are available with the following ML2000 and ML20600 Series functions.

ML2002, ML2003, ML2004, ML2011, ML2012, ML2013, ML2017, ML2020, ML2022, ML2024, ML2029, ML2030, ML2040, ML2048, ML2049, ML2059, ML2060, ML2062, ML2065, ML2067, ML2068, ML2069, ML2072, ML2073, ML2075, ML2082, ML2092, ML20608 x NAC x SEC x PHR, ML20609 x NAC x SEC x PHR

See pages 4-9 & 21 for details.

# Indicators

## SECTIONAL TRIM

- Surface mounted
- Torx security screws provided
- Compatible with all sectional trim rose designs except E4
- Provided with standard thumbturn design. Available with ergonomic and all decorative thumbturns as shown on pages 70-71.
- Available with optional directional arrow engraving (see page 68)
- Not compatible with master ring cylinders
- Not compatible with BHSS, BLSS, or HSS trims

Specify option code when ordered with lock. See page 67 for indicator option codes.

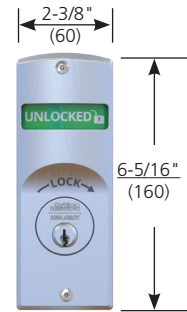

Shown with optional directional arrow engraving

## RETROFIT/UPGRADE KITS

Retrofit/upgrade kits are available for existing applications only. Each kit includes one indicator plate with mechanism, screw pack, plastic template and instructions.

To order retrofit/upgrade kits only, specify by model number below based upon function and mounting location. Door thickness and indicator option code must also be specified with kit.

Kits are handed and easily field reversible. All units are shipped from the factory with a default handing. Handing must be field verified and adjusted as needed per product installation instructions.

Retrofit/upgrade kits with directional engraving must include lock handing and lock function details.

See page 68 for how to order examples. Note: Indicators for both sides of door require two kits.

Illustration	Model #	Used with Functions	Available Option Codes	Indicator Location*
	ML190	ML2002, ML2003, ML2004, ML2011, ML2012, ML2013, ML2017, ML2022, ML2024, ML2029, ML2048, ML2049, ML2059, ML2062, ML2065, ML2067, ML2068, ML2069, ML2072, ML2073, ML2075, ML2082, ML2092, ML20608 x NAC x PHR	Outside Trim: V10, V10F, V20, V20F, V30, V40, V50, V60 Inside Trim: V01, V01F, V03, V04, V06	Inside and/or Outside per Function
	ML193	ML2020, ML2030, ML2060	V10, V10F, V20, V20F, V30, V40, V50, V60	Outside
	ML194	ML2004, ML2013, ML2017, ML2020, ML2024, ML2029, ML2030, ML2040, ML2048, ML2049, ML2060, ML2065, ML2067, ML2068, ML2069, ML2075, ML20608 x NAC x PHR, ML20609 x NAC x PHR	V01, V01F, V03, V04, V06	Inside
	ML197	ML2003, ML2011, ML2040, ML2059, ML2073, ML20609 x NAC x PHR	Outside Trim: V10, V10F, V20, V20F, V30, V40, V50, V60 Inside Trim: V01, V01F, V03, V04, V06	Inside or Outside per Function

\*When indicators are required on both sides of the door, 2 upgrade kits must be ordered, one kit for each side.

# Indicators

## ESCUTCHEON TRIM

- Unique escutcheon (VN) for both inside and outside of door for indicator functions
- Non-indicator functions provide with standard escutcheons as ordered, i.e. M, N, P, R, L
- Through-bolted
- Torx security screws optional
- Provided with standard thumbturn design. Available with ergonomic and all decorative thumbturns as shown on pages 70-71.
- Available with optional directional arrow engraving (see page 68)
- Not compatible with select lever designs: 121, 133, 134, 135, 136, 137, 138, 139, 140, 143, 147, 148, 149
- Not compatible with master ring cylinders
- Not available with ML2011, ML2012 and ML2013

Specify option code when ordered with lock. See page 65 for indicator option codes.

## TRIM KITS

Complete trim kits are available to retrofit/upgrade existing applications.

Trim kit includes levers and escutcheons with mechanism for both sides of door, screw pack, door marker and instructions.

To order trim kit only, specify by adding option code M31 and the indicator option code (see pg. 68 for codes) to the complete order string. See page 68 for how to order examples.

Option Code	Functions
M31	All functions*

\*Escutcheon indicator trim kits available for all functions as listed on page 64 except ML2011, ML2012 and ML2013

Note: Escutcheon applications require both sides of the door to have the unique VN escutcheon. Kits will be provided as a set.



Shown with optional directional arrow engraving

# Indicators

## INDICATOR OPTION CODES

ML2000 Series indicator option codes are designed to convey wording, color and side of door desired in one simple code. To order, specify option code for complete locksets and/or retrofit/upgrade trim kits.

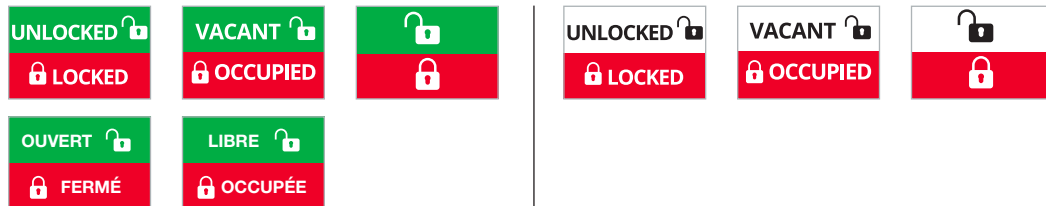

Single Indicator			
Option Code	Outside Wording	Inside Wording	Color
V10	Unlocked/Locked	No Indicator	Green/Red
V10F	Ouvert/Fermé	No Indicator	Green/Red
V20	Vacant/Occupied	No Indicator	Green/Red
V20F	Libre/Occupée	No Indicator	Green/Red
V30	Icons Only	No Indicator	Green/Red
V40	Unlocked/Locked	No Indicator	White/Red
V50	Vacant/Occupied	No Indicator	White/Red
V60	Icons Only	No Indicator	White/Red
V01	No Indicator	Unlocked/Locked	Green/Red
V01F	No Indicator	Ouvert/Fermé	Green/Red
V03	No Indicator	Icons Only	Green/Red
V04	No Indicator	Unlocked/Locked	White/Red
V06	No Indicator	Icons Only	White/Red
Double Indicator			
Option Code	Outside Wording	Inside Wording	Color
V11	Unlocked/Locked	Unlocked/Locked	Green/Red
V11F	Ouvert/Fermé	Ouvert/Fermé	Green/Red
V21	Vacant/Occupied	Unlocked/Locked	Green/Red
V21F	Libre/Occupée	Ouvert/Fermé	Green/Red
V33	Icons Only	Icons Only	Green/Red
V44	Unlocked/Locked	Unlocked/Locked	White/Red
V54	Vacant/Occupied	Unlocked/Locked	White/Red
V66	Icons Only	Icons Only	White/Red
Engraving			
Option Code	Outside	Inside	Wording
EMA	Engraving	No Engraving	"Lock" with arrow
EMB	No Engraving	Engraving	"Lock" with arrow
EMC	Engraving	Engraving	"Lock" with arrow

# Indicators

## ENGRAVING OPTIONS

- Laser engraving with "LOCK" and directional arrow
- Only available in the following finishes: 605, 606, 618, 619, 625, 626, 626C, 629, 630, 630C
- Available with MicroShield®
- Door handing must be specified

Option Code	Description
EMA	Engraving located on outside of door
EMB	Engraving located on inside of door
EMC	Engraving located on inside and outside of door

Note: Engraving is available as an option for all functions when ordered with an indicator. Option codes must be specified with complete lock and/or retrofit (upgrade)/trim kits. EMC is not available with sectional trim upgrade kits.

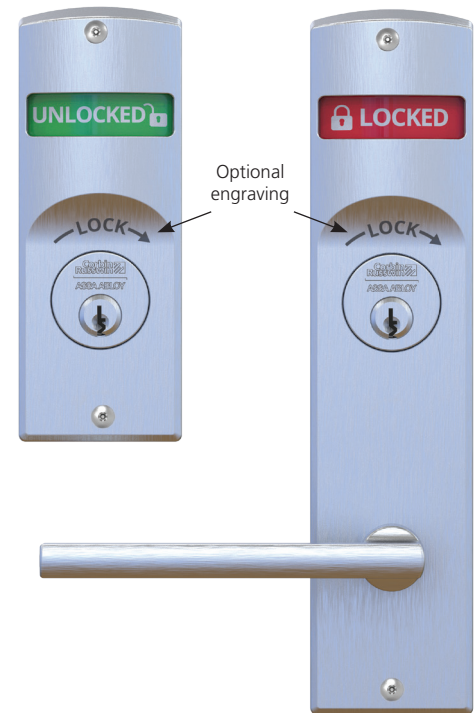

## HOW TO ORDER EXAMPLES

### COMPLETE WITH LOCK

#### Sectional Trim

Function	Lever	Rose	Hand	Finish	Options
ML2002	NS	A	RH	626	V01

Classroom Intruder function x sectional trim x single indicator inside – Unlocked/Locked – Green/Red

#### Escutcheon Trim

Function	Lever	Escutcheon	Hand	Finish	Options
ML2060	NS	VN	RH	626	V21 x EMB

Privacy function x escutcheon trim x double indicator - Vacant/Occupied - Green/Red (Outside)  
Unlocked/Locked - Green/Red (Inside) x inside engraving with "Lock" and directional arrow

### RETROFIT (UPGRADE)/TRIM KIT ONLY

#### Sectional Trim\*

Model #	Door Thickness	Finish	Options
ML190	1-3/4"	626	V01

Keyed function indicator for sectional trim x single indicator inside – Unlocked/Locked – Green/Red

\* When indicators are required on both sides of the door, 2 upgrade kits must be ordered, one kit for each side.

All units are shipped from the factory with a default handing. Handing must be field verified and adjusted as needed per product installation instructions.

#### Escutcheon Trim

Function	Lever	Escutcheon	Hand	Finish	Options
ML2030**	NS	VN	RH	626	V21 x EMB x M31

Privacy function x escutcheon trim x double indicator - Vacant/Occupied - Green/Red (Outside)

Unlocked/Locked - Green/Red (Inside) x inside engraving with "Lock" and directional arrow x full working trim only

\*\*The function of the existing lock is required so the proper escutcheons can be provided.

# Indicators

## SECTIONAL TRIM ONLY INDICATORS

The following indicators are available with sectional trim only and have different features and options than the indicators found on pages 64-68. To order the following sectional indicators with locksets, specify option codes M19S, M19V or M19N for single indicator and M19SN or M19VN for double indicators. See page 82 for option codes. Kits are available by specifying by part number as listed below. Sectional trim only indicators are available in functions as listed on pages 4-9 and 21.

### Features:

- Design eliminates unauthorized entry via indicator tampering
- Non keyed indicators available with emergency slot turn override
- For use outside, inside or both sides of door
- Choose outside indicator text: Vacant/Occupied or Secure/Unsecure
- Torx pin security fasteners (standard with cylinder indicators)

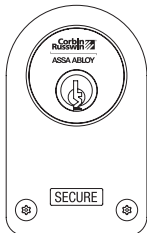

### KEYED FUNCTIONS

- Can be used on either side of door for double cylinder functions
- Compatible with select sectional trim rose designs: A, B, E3, H, W, X, Y
- Not available with Master Ring cylinders

Secure (M19S)	
Door	Packet
1-3/8" (35mm)	720F21 x Finish
1-3/4" (44mm) - 2" (51mm)	720F22 x Finish
2-1/4" (57mm)	720F24 x Finish
Over 2-1/4" (57mm)	720F25 x Finish

Vacant (M19V)	
Door	Packet
1-3/8" (35mm)	741F21 x Finish
1-3/4" (44mm) - 2" (51mm)	741F22 x Finish
2-1/4" (57mm)	741F23 x Finish
Over 2-1/4" (57mm)	741F24 x Finish

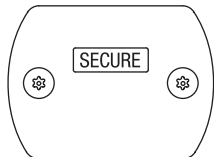

Inside Indicator

### NON KEYED FUNCTIONS

- Inside Indicator always reads Secure/Unsecure
- Outside Indicator features slot-turn emergency override
- Compatible with all sectional trim rose designs: A, B, E2, E3, E4, F, G, H, T, U, V, W, X, Y

Secure (M19S)	
Door	Packet
1-3/8" (35mm)	721F16 x Finish
1-3/4" (44mm) - 2" (51mm)	721F17 x Finish
2-1/4" (57mm)	721F18 x Finish
Over 2-1/4" (57mm)	721F19 x Finish

Vacant (M19V)	
Door	Packet
1-3/8" (35mm)	720F61 x Finish
1-3/4" (44mm) - 2" (51mm)	720F62 x Finish
2-1/4" (57mm)	720F64 x Finish
Over 2-1/4" (57mm)	720F65 x Finish



Outside Indicator

NOTE: M19S/M19SN not available with ML2020, ML2030, and ML2060

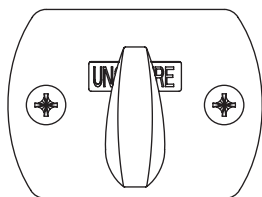

### THUMBTURN FUNCTIONS

- Located on the inside of the door and reads Secure/Unsecure
- Compatible with all sectional trim rose designs: A, B, E2, E3, E4, F, G, H, T, U, V, W, X, Y

Secure (M19N)	
Door	Packet
1-3/8" (35mm)	723F69 x Finish
1-3/4" (44mm) - 2" (51mm)	723F26 x Finish
2-1/4" (57mm)	791F59 x Finish
Over 2-1/4" (57mm)	791F60 x Finish

Note: not available with BHSS or BLSS Trim

# Thumbturns

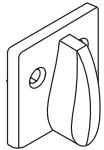
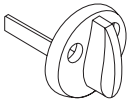

## STANDARD THUMBTURN

Cast brass or bronze. Standard on functions utilizing thumbturn. Sectional Trim.

**Turn Size:** 1-1/4" (32mm)

**Spindle Size:** 3/16" (5mm)

**Plate Size:** 1-3/8" (35mm)

Surface screw mounted To order separately, see table.

- Available with Standard, Muséo and Vineyard levers
- Rose design will designate shape of thumbturn backplate
  - Round roses - round backplate
  - E2, E3 and E4 roses - square backplate

Door	Packet	
	Round	Square
1-3/8" (35mm)	519F09 x FIN	814F10 x FIN
1-3/4" (44mm)	519F10 x FIN	814F11 x FIN
2-1/4" (57mm)	519F11 x FIN	814F12 x FIN
Up to 4" (102mm)	581F96 x FIN	814F13 x FIN

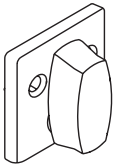

## DECORATIVE THUMBTURN MT1\*

Cast bronze or stainless steel. Used on functions utilizing a thumbturn. Sectional trim only. To order with lock and trim, specify Quick Code MT1. To order separately, see table.

**Turn Size:** 1-3/10" (33mm)

**Plate Size:** 1-1/2" (38.1mm)

- Available with Standard, Muséo and Vineyard levers
- Rose design will designate shape of thumbturn backplate
  - Round roses - round backplate
  - E2, E3 and E4 roses - square backplate

Door	Packet	
	Round	Square
1-3/8" (35mm)	723F70M x FIN	723F71M x FIN
1-3/4" (44mm)	723F76M x FIN	723F77M x FIN
2-1/4" (57mm)	723F88M x FIN	723F89M x FIN
Up to 4" (102mm)	723F82M x FIN	723F83M x FIN

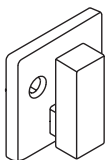
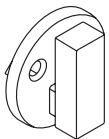

## DECORATIVE SQUARE THUMBTURN MT2\*

Cast bronze or stainless steel. Used on functions utilizing a thumbturn. Sectional trim only. To order with lock and trim, specify Quick Code MT2. To order separately, see table.

**Turn Size:** 1-3/10" (33mm)

**Plate Size:** 1-1/2" (38.1mm)

- Available with Standard, Muséo and Vineyard levers
- Rose design will designate shape of thumbturn backplate
  - Round roses - round backplate
  - E2, E3 and E4 roses - square backplate

Door	Packet	
	Round	Square
1-3/8" (35mm)	723F72M x FIN	723F73M x FIN
1-3/4" (44mm)	723F78M x FIN	723F79M x FIN
2-1/4" (57mm)	723F90M x FIN	723F91M x FIN
Up to 4" (102mm)	723F84M x FIN	723F85M x FIN

\*Not available with M19VN indicator.

# Thumbturns

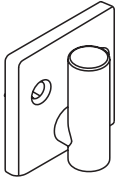
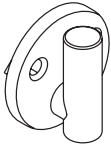

## DECORATIVE CYLINDER THUMBTURN MT3\*

Cast bronze or stainless steel. Used on functions utilizing a thumbturn. Sectional trim only. To order with lock and trim, specify Quick Code MT3.

To order separately, see table.

**Turn Size:** 1-3/10" (33mm)

**Plate Size:** 1-1/2" (38.1mm)

- Available with Standard, Muséo and Vineyard levers
- Rose design will designate shape of thumbturn backplate
  - Round roses - round backplate
  - E2, E3 and E4 roses - square backplate

Door	Packet	
	Round	Square
1-3/8" (35mm)	723F74M x FIN	723F75M x FIN
1-3/4" (44mm)	723F80M x FIN	723F81M x FIN
2-1/4" (57mm)	723F92M x FIN	723F93M x FIN
Up to 4" (102mm)	723F86M x FIN	723F87M x FIN

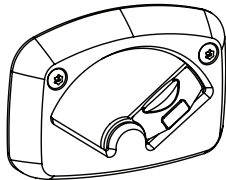

## THUMBTURN FOR BHSS, BLSS, HSS, HPSK

Stainless steel. Used on functions utilizing a thumbturn. Sectional trim only. To order, see table.

**Plate Size:** 3-3/4" (95mm) x 2-1/2" (64mm)

Door Thickness	Packet
1-3/4" (44mm)	851F627
2" (51mm)	851F637
2-1/4" (57mm)	851F647

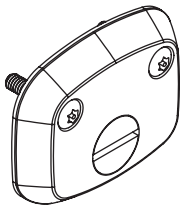

## EMERGENCY TURN FOR BHSS, BLSS, HSS, HPSK

Stainless steel. Used on functions utilizing a thumbturn. Sectional trim only. To order, see table.

**Plate Size:** 3-3/4" (95mm) x 2-1/2" (64mm)

Door Thickness	Packet
1-3/4" (44mm)	851F677
2" (51mm)	851F687
2-1/4" (57mm)	851F697

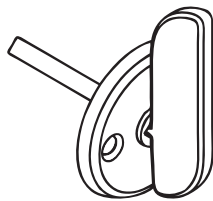

## ERGONOMIC THUMBTURN

Cast brass or bronze. Large profile and offset center makes it easier to grasp and rotate. Available on both sectional and escutcheon trim. To order with lock and trim, specify Quick Code M34. To order separately, see table.

Note: Not available with the M19N, M19SN, or M19VN indicators. Not available with HPSK trim.



Door	Packet
Escutcheon Trim up to 4" (102mm)	711F002
Sectional Trim	
1-3/8" (35mm) - 1-5/8" (41mm)	707F57 x FIN
1-3/4" (44mm) - 2" (51mm)	707F58 x FIN
2" (51mm) - 2-1/4" (57mm)	707F59 x FIN
2-3/8" (60mm) - 3" (76mm)	707F60 x FIN
3" (76mm) - 4" (102mm)	706F70 x FIN

\*Not available with M19VN occupancy indicator.

# Options and Accessories

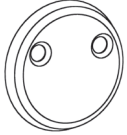

## BLANK PLATE

For use on doors where standard thumbturn is no longer used. To order, specify 696F39 x Finish.

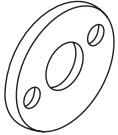

## KEY PLATE

Cast brass or bronze. Standard for privacy function with emergency release only. Sectional Trim.

**Plate Size:** 1-3/8" (35mm) diameter. To order separately, specify Packet 438F90 x Finish.



## TAPERED CYLINDER COLLAR

Furnished only for CSV or NSV trims with 1-1/4" cylinders, double cylinder functions or with 1-1/2" cylinders, single cylinder functions.\*

\*1-3/4" thick doors. Only used with VR trims.

# Options and Accessories

## CYLINDERS

2 nickel silver keys  
 Finishes: See Key Systems catalog



Mortise Cylinder Type	Quick Code	Hotel Function	42 (inside) 52, 53, 55, 56, 58, 69 Functions	All Other Keyed and 42 (outside) Functions
Access 3® Patented	AP	CR1501-114-A01	CR1500-114-A02	CR1500-114-A01
Access 3® Security	AS	CR1601-114-A01	CR1600-114-A02	CR1600-114-A01
Access 3® High Security	AHS	CR1701-114-A01	CR1700-114-A02	CR1700-114-A01
Access 3® Patented LFIC	ACP	N/A	CR1580-114-A02	CR1580-114-A01
Access 3® Security LFIC	ACS	N/A	CR1680-114-A02	CR1680-114-A01
Access 3® High Security LFIC	ACHS	N/A	CR1788-114-A02	CR1788-114-A01
Pyramid HS	PHS	N/A	CR1020-114-A02	CR1020-114-A01
Pyramid HS LFIC	PCHS	N/A	CR1030-114-A02	CR1030-114-A01
Pyramid Security	PS	N/A	CR1027-114-A02	CR1027-114-A01
Pyramid Security LFIC	PCS	N/A	CR1037-114-A02	CR1037-114-A01
Conventional 6-pin	N/A	CR1001-114-A01	CR1000-118-A02	CR1000-118-A01
Conventional 7-pin	7P	N/A	CR1000-114-A02-7	CR1000-114-A01-7
6-pin LFIC	C6	CR1081-138-A01	CR1080-114-A02	CR1080-114-A01
7-pin LFIC	C7	N/A	CR1080-112-A02-7	CR1080-112-A01-7
6-pin SFIC	C6S	N/A	CR1050-114-A02	CR1050-114-A01
7-pin SFIC	C7S	N/A	CR1050-114-A02-7	CR1050-114-A01-7
Security	HS	CR1011-114-A01	CR1010-118-A02	CR1010-118-A01
Security LFIC	CHS	CR1091-138-A01	CR1090-114-A02	CR1090-114-A01
Flex head 6-pin	FX6	CR1101-118-A01	CR1100-100-A02	CR1100-100-A01
Flex head 7-pin	FX7	N/A	CR1100-118-A02-7	CR1100-118-A01-7
Master ring**	MR	N/A	CR1060-118-A62	CR1060-118-A61
Master ring flex head**	FXM	N/A	CR1160-100-A62	CR1160-100-A61
Plug only to show-6-pin	P06	CR1201-114-A01	CR1200-118-A02	CR1200-118-A01
Plug only to show 7-pin	P07	N/A	CR1200-114-A02-7	CR1200-114-A01-7

To order optional cylinder with lockset, see Quick Codes, page 80.  
 To order cylinder separately, specify Part No. x Keyway x Finish (e.g., CR1000-118-A01 x L4 x 626). Refer to ML2000 Series parts manual for collar requirements.

\*\*Not available for the following functions: ML2017, ML2029, ML2032, ML2068, ML20900, ML20600 x NAC, ML2000VR, or MELR option.. Available for "M" escutcheon and sectional trim only.

**Note: Master ring cylinder meets ANSI/BHMA operational Grade 1.**

### PLUG ONLY TO SHOW (CONCEALED SHELL)

Only the cylinder plug face is visible when lock trim is in place. Available with "M", "R", and "L" escutcheons. See individual trim designs for availability.

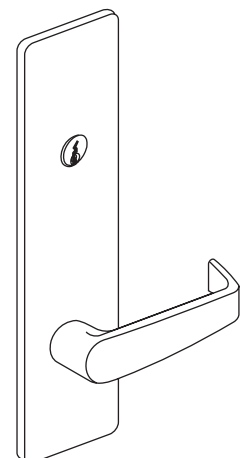

# Options and Accessories



## STRIKES

### ANSI Straight Lip (standard)

- Brass or stainless steel
- Non-handed
- 4-7/8" (124mm) x 1-1/4" (32mm) x 1-1/8" (29mm) lip to center (standard)
- Optional lip lengths: See chart on page 79

### ANSI Curved Lip

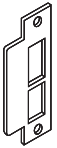
- Brass or stainless steel
- Handed
- 4-7/8" (124mm) x 1-1/4" (32mm) x 1-1/4" (32mm) lip to center (standard)
- Optional lip lengths: See chart on page 79

	Part No.	Description
Note: Only Available with ML2000	236L72	Straight Lip
	340L60	Curved Lip for RH/LHR
 LH Shown	340L61	Curved Lip for LH/RHR

All Functions

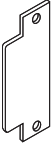
	236L70	Straight Lip
-------------------------------------------------------------------------------------	--------	--------------

Blank Filler Plate

To order strike with lockset, see How to Order, page 78.  
 To order strike separately, specify Part No. x Lip Length x Finish (e.g., 340L60 x 1-1/2" x 626).

### ANSI Wrought Strike Box

- To order with lockset, see Quick Codes, page 81.
- To order separately, specify 120F76.



### Open Back

- Size: 4-7/8" (124mm) x 1-1/4" (32mm)
- Finish: Black Nylon.
- Available separately.
- To order, specify Part Number.

Hand	Door Thickness	Part
RHR/LHR	1-3/4" (44mm)	653L163016
	2-1/4" (57mm)	653L163020

### Rabbeted Front and

#### Strike

- Stainless Steel
- For 1/2" (13mm) rabbet
- No optional lip lengths
- Non-handed

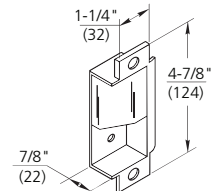

	Part No.
All Functions	318F66

To order with lockset, see Quick Codes, page 81. To order separately, specify Part No. x Finish (e.g., 318F66 x 626).

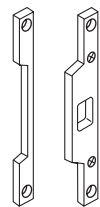

# Options and Accessories

## LSP-12-24 POWER SUPPLY

### Operation

LifeSafety Power supplies are designed to provide reliable filtered and regulated power for long life to a variety of electrified hardware components.

### Features

- Selectable voltage output between 12V and 24V with a single switch
- Internal Back-Up battery charging circuit\*
- Regulated and filtered, fuse protected outputs
- Each output can be individually turned on and off via a jumper
- Power status of each output is shown by an LED
- Rugged steel enclosure
- Fire alarm interface included – Dry contacts NO/NC, 9-33VDC, 3-15mA

### Electrical Specifications

- Inputs: 120VAC
- Outputs: 12VDC @ 6 Amp or 24VDC @3 Amp
- 8 Total Outputs

### Listings

- UL294, UL603, UL1076
- ULC S318, ULC S319

### Applications

- Fail safe mortise locks
- Fail secure mortise locks
- MELR

\*Note: Batteries are not included with the power supply



Model #	Description
LPS-24-1	12V - 6AMP / 24V - 3AMP Power Supply

## REQUIREMENTS FOR ELECTRICAL AND DATA TRANSFER

To answer the demand for "smart" electronic access control and locking solutions that require fast, easy, and cost-effective installation, ASSA ABLOY Group brands use the ElectroLynx® standardized plug-in connectors and color-coded wiring system.

With ElectroLynx, doorway components come pre-wired for easy hookup to the power source. The key to the system is the transfer device hinge that carries power from the frame to the locking hardware.

### Features of ElectroLynx:

- Makes it easy to bring power to the locking hardware
- Wires have connectors that snap together, like plugging a telephone into a jack

To connect a ML20900 electrified mortise lock to the electronic access control system, the following items are required:

- ML20900 electrified mortise lock
- ASSA ABLOY Door Group pre-wired door, or ElectroLynx retrofit cable (order from McKinney)

- Electronic transfer device (ElectroLynx electronic transfer hinge or Electrical Power Transfer with standard hinge, from McKinney)
- ElectroLynx cable from the hinge to above the ceiling (order from McKinney)

Information regarding cable selection, hinge requirements and order strings can be found in the McKinney Transfer Device Solutions catalog. Consult 800-810-WIRE (9473) with questions on application specifications and requirements.

The McKinney QC8 ElectroLynx Hinge is recommended for all ML20900 functions and electrified options.

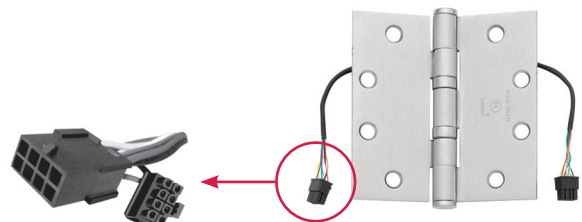

# Electrified Options & Accessories

## EXIT CONTROLS AND SWITCHES

### Key Switches

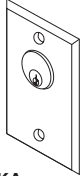

MKA

MKA - (1) SPDT Maintained  
 MK - (1) SPDT Momentary  
 MKN - (1) SPDT Momentary NS  
 MK2 - (1) DPDT Momentary  
 MKPZ x MKS - (1) SPDT Momentary with audio Double Gang x Additional Switch  
 Note: All key switches come standard with 12/24 VDC bi-color LED.

#### Specifications

- Keyswitch for operation using a standard 1-1/8" mortise cylinder (A02 cam) (cylinder not included).
- Contact Rating 5 Amps @ 12-24VDC
- SPDT 3-position.

### Push Buttons

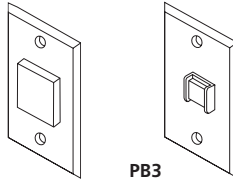

PB2

PB3

PB2 - (1) SPDT Momentary  
 PB2 - (1) DPST Remote Momentary  
 PB3 - (1) DPST Momentary  
 PB3A - (1) DPST Maintained (Alt. Action)  
 PB3EA - (1) DPST Alternate

#### Specifications

- 3 Amps @ 12-24 VDC

#### Indicator

ZLP - (1) Red and Green LED on narrow gang plate.

### Audible/Visual Annunciators



PZ1

PZ1 - Sonalert 90db @ 2ft. 12-24VDC.  
 Mounted on one gang stainless steel plate.

#### Digital Entry

DK-11 - Digital Keypad - 4 User  
 DK-26SS - Digital Keypad NS - 59 User - SS Finish  
 DK-26BK - Digital Keypad NS - 59 User - Black Finish

#### Power Transfers

TSB B-C - Door Cord

# How to Order

## ORDERING EXAMPLES - ML2000 SERIES

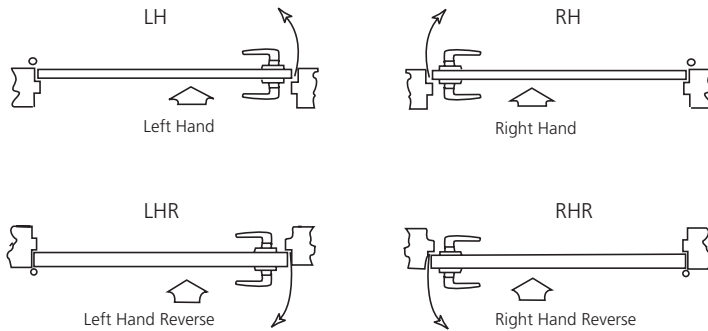

Note: Arrow indicates secure side of door.

## WHERE TO FIND ORDERING INFORMATION AND QUICK CODES

Mechanical Functions	4-9
Electrified Functions	17-18
Trim Designs	22-58
Cylinder and Keying	80
Finish	80
Strikes	81
Miscellaneous Options	81
Door Thickness	81
Handing	82
Indicators	82

## STOCK ORDER

Quantity	Series/Function	Trim	Finish	Hand
100	ML2055	LWA	626	RHR

## SPLIT TRIM / FINISH ORDER

Quantity	Series/ Function	Trim		Finish		Hand
		Outside	Inside	Outside	Inside	
12	ML2055	LWA	GZH	626	625	RHR
12	ML2055	ZSL	—	626	625	RHR
24	ML2051	MSG	—	605	625	LH
12	ML2055	102U	—	626	606	RHR
24	ML2051	122R	110R	605	625	LH

## CONTRACT / DETAILED ORDER

Quantity	Keyset	Series/ Function	Trim	Finish	Hand	Door Thickness	Optional Strike	Misc. Options	Optional Cylinder	Keying
24	AA1	ML2055	LWA	626	RHR	D214	SA200	M17-M26	C7	VKC3
6	AA1	ML2055	NSV	630	RH	D214	SS114	M17	PCHS	VKC1

## WORKING TRIM ONLY

Quantity	Function Only	Trim	Finish	Hand	Door Thickness	Misc. Options
6	ML2055	LWA	626	RHR	D214	M31
1	ML2055	NSV	630	RH	D214	M31

(Includes grip and spindle, rose or escutcheon, thumbturn lever, emergency key plate, adapters and screws)

# How to Order

## LOCK ONLY (INCLUDES LOCK CASE, ARMORED FRONT, STRIKE AND SCREW PACK)

Quantity	Series/ Function	Trim*	Finish	Hand	Door Thickness	Optional Strike	Misc. Options
6	ML2055	LL	626	RHR	D138	SS078	M17

**\*TRIM KEY**

KK	Knob x Knob
LL	Lever x Lever
LK	Lever x Knob
KL	Knob x Lever
HL	Lever Inside Only
HK	Knob Inside Only
LLBHSS	BHSS

## ORDERING EXAMPLES - ML20900

### Lock Only (Includes lock case, armored front, strike and screw pack)

Quantity	Series/ Function	Trim*	Finish	Hand	Fail Safe/ Fail Secure	Misc. Options
6	ML20914	LL	626	RHR	SAF	M105

**\*TRIM KEY**

KK	Knob x Knob
LL	Lever x Lever
LK	Lever x Knob
KL	Knob x Lever
HL	Lever Inside Only
HK	Knob Inside Only
LLBHSS	BHSS

### Contract / Detailed Order

Quantity	Keypad	Series/ Function	Trim	Finish	Hand	Fail Safe/ Fail Secure	Misc. Options	Optional Cylinder	Keying
24	AA1	ML20914	LWA	626	RHR	SEC	M20	7P	VKC3

## ORDERING EXAMPLES - ML20600 NAC

### Stock Order

Quantity	Series/Function	Technology Code	Trim	Finish	Hand	Fail-Safe/ Fail-Secure	High Security Monitoring Options
24	ML20608	NAC	111X	626	RHR	SEC	PHRR01

- ML2000 Mortise Lock x NAC x No Cylinder x Deadbolt x Fail-Secure
- Muséo® lever 111 with X rose
- Satin chrome finish
- Right hand reverse
- Deadbolt privacy function, Mercury and Lenel compatible 1KΩ/2KΩ resistance supervision

### Stock Order

Quantity	Series/Function	Technology Code	Trim	Finish	Hand	Fail-Safe/ Fail-Secure	High Security Monitoring Options
24	ML20607	NAC	111X	626	RHR	SEC	R03

- ML2000 Mortise Lock x NAC x No Cylinder x No Deadbolt x Fail-Secure
- Muséo® lever 111 with X rose
- Satin chrome finish
- Right hand reverse
- Software House compatible 1KΩ/2KΩ resistance supervision

# How to Order the Muséo® Piet Levers



**Grooved Insert  
21G**



**Leather Insert  
21L**



**Polished with  
Satin Insert  
21M**



**Santoprene™  
Insert  
21S**



**With Raised Band  
23M**



**Plain  
25M**



**Plain with Two  
Grooves  
27M**

## PIET FINISH CODES

ANSI/BHMA & Corbin Russwin Finish Code	Piet Code*	Description
630	30	Satin Stainless Steel
629	29	Bright Stainless Steel
N/A	BK	Black (Santoprene™ or leather insert)
N/A	BN	Brown (leather insert)
N/A	00	No Insert
613E	3E	Dark Satin Bronze Equivalent
BSP	BS	Black Suede
WSP	WS	White Suede

\*Code used to specify Piet Collection finishes only. Use available finishes list to specify desired finish when ordering.

## PIET LEVER DESCRIPTIONS & AVAILABLE FINISHES

Lever Designation	Lever Description	Available Finishes (as ordered)
21G	Grooved Insert	303030, 292929, 293029, 302930, 3E003E, BS00BS, WS00WS
21L	Leather Insert	30BK30, 30BN30, 29BK29, 29BN29, 3EBK3E, BSBKBS, WSBKWS, 3EBN3E, BSBNBS, WSBNWS
21M	Metallic Insert	293029**
21S	Santoprene Insert	30BK30, 29BK29, 3E003E, BS00BS, WS00WS
23M	Raised Band	290030**, 290029, 300030, 300029***, 3E003E, BS00BS, WS00WS
25M	Plain	290029, 300030, 3E003E, BS00BS, WS00WS
27M	Two Grooves	290029, 300030, 3E003E, BS00BS, WS00WS

\*\*Two-tone finish - grip of lever is 630, balance of lever is 629. Rose/escutcheon and lock finish will be 629.

\*\*\*Two-tone finish - grip of lever is 629, balance of lever is 630. Rose/escutcheon and lock finish will be 630.

## ORDERING EXAMPLES

Rose Options: E2, E3, E4, T, U, V, W, X, Y

Escutcheon Options: L, R

Quantity	Series/ Function	Trim	Lever Finish	Lock Finish	Hand	Thumbturn Options
2	ML2054	21LU	29BK29	629	RH	MT3
1	ML2054	23ML	290030	629	RH	MT3

# Quick Codes

## CYLINDER AND KEYING

Description	Specify
Conventional 6-pin	(standard)
Conventional 7-pin	7P
Less Cylinder(s)	LC
<b>LFIC</b>	
LFIC 6-pin	C6
LFIC 6-pin Less Core	CL6
LFIC 6-Pin Disposable Core	CT6D
LFIC 6-pin with Temporary Construction Core (Red)	CT6R
LFIC 6-pin with Temporary Construction Core (Blue)	CT6B
LFIC 6-pin with Temporary Construction Core (Green)	CT6G
LFIC 7-pin	C7
LFIC 7-pin Less Core	CL7
LFIC 7-Pin Disposable Core	CT7D
LFIC 7-pin with Temporary Construction Core (Red)	CT7R
LFIC 7-pin with Temporary Construction Core (Blue)	CT7B
LFIC 7-pin with Temporary Construction Core (Green)	CT7G
<b>SFIC</b>	
SFIC 6-pin	C6S
SFIC 6-pin Less Core <sup>1</sup>	CLS6
SFIC 6-Pin Disposable Core <sup>1</sup>	CT6SD
SFIC 6-pin with Temporary Construction Core (Blue)	CT6SB
SFIC 7-pin	C7S
SFIC 7-pin Less Core <sup>1</sup>	CLS7
SFIC 7-Pin Disposable Core <sup>1</sup>	CT7SD
SFIC 7-pin with Temporary Construction Core (Blue)	CT7SB
<b>Security</b>	
Security	HS
Security LFIC	CHS
<b>Access 3<sup>®</sup></b>	
Access 3 <sup>®</sup> Patented Fixed Core	AP
Access 3 <sup>®</sup> Security Fixed Core	AS
Access 3 <sup>®</sup> High Security Fixed Core	AHS
Access 3 <sup>®</sup> Patented LFIC	ACP
Access 3 <sup>®</sup> Security LFIC	ACS
Access 3 <sup>®</sup> High Security LFIC	ACHS
<b>Pyramid</b>	
Pyramid Security Fixed Core	PS
Pyramid High Security Fixed Core	PHS
Pyramid Security LFIC	PCS
Pyramid High Security LFIC	PCHS
Pyramid LFIC Less Core	CLP
Pyramid with Temporary Construction Core	CTP
Pyramid Disposable Core	CTPD
<b>UL Housing</b>	
LFIC 6-pin Less Core <sup>3</sup>	CL6AH
LFIC 6-Pin Disposable Core <sup>3</sup>	CTAHD
LFIC 6-pin with Temporary Construction Core (Red/Blue/Green) <sup>3</sup>	CT6AH (R/B/G)

## CYLINDER AND KEYING (CONT.)

Description	Specify
<b>Other</b>	
Master Ring <sup>2,4</sup>	MR
Flex Head Cylinder, 6-pin (sectional trim) <sup>3</sup>	FX6
Flex Head Cylinder, 7-pin (sectional trim) <sup>3</sup>	FX7
Flex Head Cylinder, Master Ring (sectional trim) <sup>2,3</sup>	FXM
Plug Only to Show, Less Cylinder	PO-LC
Plug Only to Show, 6-pin (concealed shell; M and R escutcheons only, single cylinder only) <sup>3</sup>	PO6
Plug Only to Show, 7-pin (concealed shell; M and R escutcheons only, single cylinder only) <sup>3</sup>	PO7
<b>Keying and Keys</b>	
0-bitted with 2 blank keys	OBit (standard)
Keyed Random	KR
Construction Master Keyed (not available for Pyramid)	CMK
Uncombined	UC (standard)
2 keys per lock	KY# (e.g., KY6)
More than 2 keys	
<b>Visual key control (VKC)</b>	
No bitting or keyset stamping on keys or cylinder	VKC0
Keys only	VKC1
Cylinders and keys (not for AS, AHS, ACS, ACHS, HS, CHS, PHS or PCHS)	VKC2
Cylinders only (not for AS, AHS, HS, ACS, ACHS, CHS, PHS or PCHS)	VKC3
<b>Concealed key control (CKC)</b>	
CKC cylinders with VKC keys	CKC2
CKC cylinders only (not for AS, AHS, HS, ACS, ACHS, CHS, PHS or PCHS)	CKC3

1. Not available with ML2029.
2. Not available for ML2017, ML2029, ML2032, ML2068, ML2000VR, ML20600 x NAC, ML20900, or MELR option.
3. Not available with ML2000VR
4. Not available UC (uncombined)

## FINISHES

ANSI/BHMA 605 (US3)	Bright Brass
ANSI/BHMA 606 (US4)	Satin Brass
ANSI/BHMA 611 (US9)	Bright Bronze
ANSI/BHMA 612 (US10)	Satin Bronze
ANSI/BHMA 613 (US10B)	Oxidized Bronze, oil rubbed
613E (US10BE)	Dark Oxidized Satin Bronze - Equivalent
613L	Dark Oxidized Satin Bronze, Clear Coated
ANSI/BHMA 618 (US14)	Bright Nickel Plated
ANSI/BHMA 619 (US15)	Satin Nickel Plated
ANSI/BHMA 625 (US26)	Bright Chromium Plated
ANSI/BHMA 626 (US26D)	Satin Chromium Plated
626C	Satin Chromium Plated with MicroShield <sup>®</sup>
ANSI/BHMA 629 (US32)	Bright Stainless Steel
ANSI/BHMA 630 (US32D)	Satin Stainless Steel <sup>®</sup>
630C	Satin Stainless Steel with MicroShield <sup>®</sup>
722	Black Oxidized Bronze, oil rubbed
BSP	Black Suede Powder Coat
WSP	White Suede Powder Coat

# Quick Codes

## MISCELLANEOUS OPTIONS

Description	Specify
Spanner head screws	M02
Torx® head screws (not available for "N" escutcheon trims (Standard for ML2000VR. Optional for other trims)	M04
Blank Escutcheon Inside (only available for ML2000VR, not available for ML2000)	M07
ANSI wrought strike box	M17
4Knurling outside and inside	M20 <sup>3</sup>
4Knurling outside only	M21 <sup>3</sup>
4Knurling inside only	M22 <sup>3</sup>
4Abrasive coat outside and inside	M23
4Abrasive coat inside only	M24
4Abrasive coat outside only	M25
Non-ferrous lockcase (ML2000 only)	M26
Lead-wrapped case	M29
Half trim (for ML2010, ML2020, ML2022, ML2024, ML2029, ML2030, ML2032, ML2052, ML2053, ML2055, ML2056, ML2057, ML2058, ML2059, ML2062, ML2065) (Supplied with inside trim only. Includes cylinder) <sup>1,2</sup>	M30
Working trim only	M31
Tapered Cylinder Collar (HPSK only) <sup>1</sup>	M111
Motorized Electric Latch Retraction (for ML2010, ML2032, ML2057)	MELR
Latch hold back (for ML2042, ML2052, ML2053, ML2054, ML2055, ML2051, ML2057 only) <sup>1</sup>	LHB <sup>5</sup>
Laser Engraving	Contact Factory

1. Not available with R-Escutcheons or ML2000VR
2. Available for 1-3/8" (35mm), 1-3/4" (44mm), 2" (51mm) or 2-1/4" (57mm) thick doors.
3. All levers provided in a powder coat finish will be supplied with an abrasive coating. D138 option not available for ML20900 or ML20600-NAC
4. Not available with Vineyard™ or Muséo® levers
5. Must use A02 cam when LHB is specified, D138 option not available for ML20900 or ML20600-NAC

## DOOR THICKNESS<sup>+</sup>

Door Thickness	Sectional Trim - Specify	Escutcheon* Trim - Specify
1-3/8" (35mm)**	D138	D138
1-3/4" (44mm)	(standard)	(standard)
1-7/8" (48mm)	D178	D178
2" (51mm)	D200	D200
2-1/8" (54mm)	D218	D218
2-1/4" (57mm)***	D214	D214
2-3/8" (60mm)	D238	D238
2-1/2" (64mm)	D212	D212
2-5/8" (67mm)	D258	D258
2-3/4" (70mm)	D234	D234
2-7/8" (73mm)	D278	D278
3" (76mm)	D300	D300
3-1/8" (79mm)	D318	D318
3-1/4" (83mm)	D314	D314
3-3/8" (86mm)	D338	D338
3-1/2" (89mm)	D312	D312
3-5/8" (92mm)	D358	D358
3-3/4" (95mm)	D334	D334
3-7/8" (98mm)	D378	D378
4" (102mm)	D400	D400

- + HPSK is only available for 1-3/4" door thickness
- \* For 2-3/8" (60mm) to 4" (102mm) door thickness: throughbolts and thumbturn lever spindle for 4" door will be provided; may be field cut. "R" & "L" escutcheons only available 1-3/8" (35mm), 1-3/4" (44mm), and 2-1/4" (57mm).
- \*\* 1-1/16" (27mm) front standard for 1-3/8" (35mm) door, D138 option not available for ML20900 or ML20600-NAC
- \*\*\*Maximum door thickness for knob trim is 2-1/4" (D214)

Available for ML2000VR		
ANSI Lip to Center	ANSI Straight Lip Specify	Curved Lip Specify
7/8" (22mm)	SS078	N/A
1-1/8" (29mm)	(standard)	SA118
1-1/4" (32mm)	SS114	SA114
1-3/8" (35mm)	SS138	SA138
1-1/2" (38mm)	SS112	SA112
1-3/4" (44mm)	SS134	SA134
2" (51mm)	SS200	SA200
2-1/4" (57mm)	SS214	SA214
2-1/2" (64mm)	SS212	SA212
2-3/4" (70mm)	SS234	SA234
3" (76mm)	SS300	SA300
Rabbeted Strike		Specify
Rabbeted front and strike		SR118

# Quick Codes

## INDICATOR OPTIONS

Description	Specify
Single Indicator Outside - Unlocked/Locked - Green/Red	V10
Single Indicator Outside - Vacant/Occupied - Green/Red	V20
Single Indicator Outside - Icons Only - Green/Red	V30
Single Indicator Outside - Unlocked/Locked - White/Red	V40
Single Indicator Outside - Vacant/Occupied - White/Red	V50
Single Indicator Outside - Icons Only - White/Red	V60
Single Indicator Inside - Unlocked/Locked - Green/Red	V01
Single Indicator Inside - Icons Only - Green/Red	V03
Single Indicator Inside - Unlocked/Locked - White/Red	V04
Single Indicator Inside - Icons Only - White/Red	V06
Double Indicator - Unlocked/Locked - Green/Red (Outside) Unlocked/Locked - Green/Red (Inside)	V11
Double Indicator - Vacant/Occupied - Green/Red (Outside) Unlocked/Locked - Green/Red (Inside)	V21
Double Indicator - Icons Only - Green/Red (Outside) Icons Only - Green/Red (Inside)	V33
Double Indicator - Unlocked/Locked - White/Red (Outside) Unlocked/Locked - White/Red (Inside)	V44
Double Indicator - Vacant/Occupied - White/Red (Outside) Unlocked/Locked - White/Red (Inside)	V54
Double Indicator - Icons Only - White/Red (Outside) Icons Only - White/Red (Inside)	V66
Single Indicator Outside - Secure/Unsecure - Green/Red (Sectional trim only)	M19S
Single Indicator Outside - Vacant/Occupied - Green/Red (Sectional trim only)	M19V
Single Indicator Inside - Secure/Unsecure - Green/Red (Sectional trim only)	M19N
"Double Indicator - Secure/Unsecure - Green/Red (Outside) Secure/Unsecure - Green/Red (Inside) (Sectional trim only)"	M19SN
"Double Indicator - Vacant/Occupied - Green/Red (Outside) Secure/Unsecure - Green/Red (Inside) (Sectional trim only)"	M19VN
Outside Engraving with "Lock" and Directional Arrow	EMA
Inside Engraving with "Lock" and Directional Arrow	EMB
Engraving Both Sides with "Lock" and Directional Arrow	EMC

Note: Contact Customer Service for other available or custom configurations

## INDICATOR OPTIONS - FRENCH

Description	Specify
Single Indicator Outside - Ouvert/Fermé - Green/Red	V10F
Single Indicator Outside - Libre/Occupée - Green/Red	V20F
Single Indicator Inside - Ouvert/Fermé - Green/Red	V01F
Double Indicator - Ouvert/Fermé - Green/Red (outside) Ouvert/Fermé - Green/Red (inside)	V11F
Double Indicator - Ouvert/Fermé - Green/Red (outside) Libre/Occupée - Green/Red (inside)	V21F

For V Series indicators only.

## HANDING

Hand	Specify
Right Hand	RH
Left Hand	LH
Right Hand Reverse	RHR
Left Hand Reverse	LHR

## ELECTRIC MONITOR OPTIONS (ML2000/ML20900 SERIES ONLY)

Description	Specify
Latchbolt Monitor	M91
Request to Exit	M92
Security Monitor	M105

These options may be ordered together only as follows: M91xM92, M92xM105.

## PANEL APPLICATIONS (Material added to the door face, increasing the overall door thickness)

Description	Specify
Centerline of lockcase to edge of panel not to exceed 2"	PNL

- Panel Application option code can only be used with 1 3/4" thick door with lock centered in door.
- You must specify the thickness of the panel and which side of the door the panel will be applied.
- All other applications require Special Product Application request.

# Quick Codes

## FUNCTIONS AVAILABLE WITH MONITOR OPTIONS

Function	M91	M92	M105	M91 + M92	M92 + M105
ML2010, ML2080, ML2090		X			
ML2020, ML2022, ML2024, ML2030, ML2062, ML2065	X	X		X	
ML2029*, ML2032*, ML2049*, ML2057*, ML2059*, ML2092*	X	X	X	X	X
ML2002, ML2003, ML2004, ML2042, ML2052, ML2053, ML2054, ML2055, ML2056, ML2058, ML2087		X	X		X
ML2048, ML2051, ML2067, ML2082	X				
ML20906, ML20907, ML20914, ML20915, ML20932, ML20987	X	X	X	X	X

\*M105 becomes DPS

Notes:

- ML2051 & ML2057 with LHB is not available with monitor options.
- Functions with monitor options are not available with M30 option (half trim).

## FAIL SAFE/FAIL SECURE

Description	Specify
Fail safe	SAF
Fail secure	SEC

## THUMBURNS

Description	Specify
Ergonomic	M34
Decorative	MT1
Decorative Square	MT2
Decorative Cylinder	MT3

See page 70-71 for images of decorative thumbturns

## ML20600NAC - END-OF-LINE RESISTORS AND DEADBOLT PRIVACY QUICK CODE

Description	Specify
No End-of-Line Resistors	Blank
Mercury / Lenel 1KΩ/2KΩ	R01
Software House 1KΩ/2KΩ	R03
AMAG 4-State Supervision	R04
Deadbolt Privacy	PHR
Deadbolt Privacy and Mercury / Lenel 1KΩ/2KΩ	PHRR01
Deadbolt Privacy and Software House 1KΩ/2KΩ	PHRR03
Deadbolt Privacy and AMAG 4-State	PHRR04

## ELECTRIC ACCESSORIES

Description	Specify
Power supply 12V – 6AMP / 24V – 3AMP	LSP-12-24

# How To Specify

## ML2000 SERIES SUGGESTED SPECIFICATION

All locksets shall be ML2000 Series Mortise Locksets as manufactured by Corbin Russwin Architectural Hardware.

Locks shall have all functions available in one size case, manufactured from heavy gauge steel, minimum thickness 3/32" (2mm). The handing of all locks shall be reversible without the disassembly of the lockcase. Cases are to be closed on all sides to protect internal parts. Locks are to have adjustable, beveled and armored fronts, standard 2-3/4" (70mm) backset, a full 3/4" (19mm) throw two-piece mechanical anti-friction latchbolt, and a one-piece stainless steel 1" (25mm) throw deadbolt, and shall be available for a minimum door thickness of 1-3/8" (35mm). Internal parts shall be heavy gauge steel, zinc dichromate plated for corrosion resistance.

All locksets with latchbolts, regardless of trim, shall be listed by Underwriters Laboratories for A label and lesser class doors, 4' x 10' single or 8' x 10' pair.

Locksets to be used on specified exterior doors or doors subject to special atmospheric conditions (roofs, pool areas, chemical laboratories, sewage disposal plants, etc.) shall have non-ferrous lock cases and critical internal components.

Cylinder options shall include master ring, flexible head, concealed shell, interchangeable core, security, Pyramid and Access 3 types.

Lock trim (knob, lever, sectional or escutcheon) shall be throughbolted through the lockcase to ensure correct alignment and proper operation.

Provide status indicators with highly reflective color and wording for "locked/unlocked" or "vacant/occupied" with customer wording options if required. Indicator to be located above the cylinder with the inside thumbturn not blocking the visibility of the indicator status. Indicator window size to be a minimum of 2.1" x 0.6" with a curved design allowing a 180 degree viewing angle with protective covering to prevent tampering.

Certification:

- UBC - 7 - 2 and UL10C - Positive Pressure
- ANSI/BHMA A156.13 Series 1000, Grade 1
- ANSI/BHMA A117.1, Accessibility Code (formerly Title 19, California State Fire Marshal Standard) (lever handle trim).

All locks, trim, and cylinders shall be from one manufacturer.

All locksets shall carry a ten-year limited mechanical warranty, five-year limited MELR warranty, and two-year limited electrical warranty.

## ML2000 SERIES MORTISE LOCKS WITH BHSS AND BLSS TRIM

- A. Ligature Resistant, Mortise: ANSI/BHMA A156.13, Series 1000, Operational and Security Grade 1 mortise type manufactured to accepted OMH requirements with ligature-resistant lever and escutcheon trim. Locksets to be manufactured with a corrosion resistant, formed steel case. Levers and escutcheons are manufactured from stainless steel material. Provide optional lead-lining (lock body), Torx® fasteners, and Antimicrobial coating as specified in Hardware Sets.
- B. Ligature Resistant, Mortise: ANSI/BHMA A156.13, Series 1000, Operational and Security Grade 1 mortise type manufactured to [accepted] [Use with caution] OMH requirements with ligature-resistant lever and rose trim. Locksets to be manufactured with a corrosion resistant, formed steel case. Levers and roses are manufactured from stainless steel material. Provide optional lead-lining (lock body), Torx® fasteners, and Antimicrobial coating as specified in Hardware Sets.

# How To Specify

## ML2000 SERIES MORTISE LOCKSETS WITH VANDAL RESISTANT TRIM SUGGESTED SPECIFICATION

All locksets shall be ML2000VR Series Mortise Locksets with Vandal Resistant Trim as manufactured by Corbin Russwin Architectural Hardware.

Locks shall have all functions available in one size case, manufactured from heavy gauge steel, minimum thickness 3/32" (2mm). The handing of all locks shall be reversible without the disassembly of the lockcase. Cases are to be closed on all sides to protect internal parts. Locks are to have adjustable, beveled and armored fronts, standard 2-3/4" (70mm) backset, a full 3/4" (19mm) throw two-piece mechanical anti-friction latchbolt, and a one-piece stainless steel 1" (25mm) throw deadbolt, and shall be available for a minimum door thickness of 1-3/4" (44mm). Internal parts shall be heavy gauge steel, zinc dichromate plated for corrosion resistance.

High security escutcheon trim shall be cast (stainless) steel with tapered design top and bottom to resist forced entry, excessive abuse and vandalism. Size to be 8-1/2" (216mm) high x 2-1/8" (54mm) wide x 5/16" (8mm) thick with double throughbolts and 2 post lugs to receive Torx® pin tamper-resistant security screws through both escutcheons. Alignment posts shall be located over and under the spindle for rigidity and security and shall project through the lock case to ensure proper alignment. Escutcheons to accept cast levers (Newport or Citation) which accept free-floating spindles with a torque resistance of 700 inch lbs. Size of spindle to be 5/16" (8mm) and extend from both sides of the escutcheon. Levers will remain attached if spindle is broken. Lobular Torx® pin drive self-tapping screws and lobular throughbolts furnished standard for vandal resistance.

Locksets that are to be used on specified exterior doors or doors subject to special atmospheric conditions (roofs, pool areas, chemical laboratories, sewage disposal plants, etc.) shall have non-ferrous lock cases and critical internal components.

Locksets to be furnished standard with conventional 6-pin fixed core cylinders. Optional cylinders shall include IC, Access 3, security and Pyramid. Furnish a tapered vandal-resistant cylinder collar where necessary.

Certification:

- UBC - 7 - 2 and UL10C - Positive Pressure
- ANSI/BHMA A156.13 Series 1000, Grade 1
- ANSI/BHMA A117.1, Accessibility Code (formerly Title 19, California State Fire Marshal Standard) (lever handle trim).

All locks, trim, and cylinders shall be from one manufacturer.

All locksets shall carry a ten-year limited mechanical warranty, five-year limited MELR warranty, and two-year limited electrical warranty.

# How To Specify

## ML20900 ECOFLEX® ELECTRIFIED SUGGESTED SPECIFICATION

### A. CORBIN RUSSWIN ML20900

#### Electrified Mortise Locks

1. General: ANSI/BHMA certified extra heavy duty, lever type mortise lock conforming to ANSI/BHMA A156.13 Series 1000, Grade 1 requirements and ANSI A117.1 accessibility guidelines. All functions manufactured in a single sized case formed from a minimum 12 gauge steel. Lockset is field-adjustable for handing without opening the lock body with a beveled armored front that is 0.125" minimum thickness and utilizes a one piece 3/4" anti-friction stainless steel latchbolt. To insure proper alignment, all trim, shall be thru-bolted and fully interchangeable between rose and escutcheon designs. Lock is UL/cUL listed and labeled for use on up to 3 hour fire rated openings.
  - a. Backsets: 2-3/4".
  - b. Deadbolt: Optional 1" throw made of stainless steel and 2 hardened steel roller inserts.
  - c. Strikes: Provide wrought boxes and strikes with proper lip length to protect trim but not to project more than 1/8" beyond trim, frame or inactive leaf. Where required, provide open back strike and protected to allow practical and secure operation.
2. Provide access control mortise lock series, type and functions where specified in hardware groups, with provisions below:
  - a. Emergency override access capability with key cylinder retraction of lock latch bolt without necessary electronic activation.
  - b. Inside lever retracts latch and deadbolt simultaneously for free egress.
  - c. Refer to "KEYING" specification section for keying system requirements.
  - d. Lever and finish to match corresponding mechanical locking hardware.
3. Locking and unlocking of the lever handle by electronic operation contained completely within the body of the mortise lock.
  - a. Field configurable Fail Safe /Fail Secure by means of an external DIP switch setting.
  - b. Operationally voltage-insensitive 12 to 24 VDC.
  - c. Energy Performance: Maximum standby current required for functional operation not to exceed 50 mA at 24 VDC limiting potential inductive kickback or the need for external diodes.
  - d. Functional locking operation not affected by cable runs greater than 500 feet using a minimum 22 AWG wire.
4. Monitoring: Optional real time monitoring of latchbolt, deadbolt, door open/closed status and valid egress where specified. Valid egress signaled by activation of the Request-to-Exit (RX) micro switch integral to the inside lever of the lockset on the unsecure side of the door capable of shunting external alarms. Door open/closed status provided by monitoring the deadlatch and latchbolt in series with optional integrated magnetic door position switch. In fail safe operation both levers activate Request-to-Exit (RX) micro switch when the lock loses power.
5. Perform centralized control of the integrated locking functions by means of a single cable run to the access control panel independent of any proprietary power supplies, interface boards or controllers.
  - a. End of line termination points by means of factory pre-wired Molex® connectors and harnesses.
  - b. Source power electrical hard wiring and connections by others.

# How to Reverse Handing

ML2000 Series Mortise Locks are easily field reversible for installation on doors of any hand. Re-handing can be done quickly and easily without opening the lock case. The following instructions apply to latchbolt assemblies that contain a Locking Pin as shown in Figure 4 below. For those assemblies that do not contain a Locking Pin, refer to the ML2000 parts manual (45556) for instructions.

1. Move the Red locking screw to side of lock-body being locked (Figure 1)
2. Push in latch partially then depress catch plate with screwdriver (Figure 1)

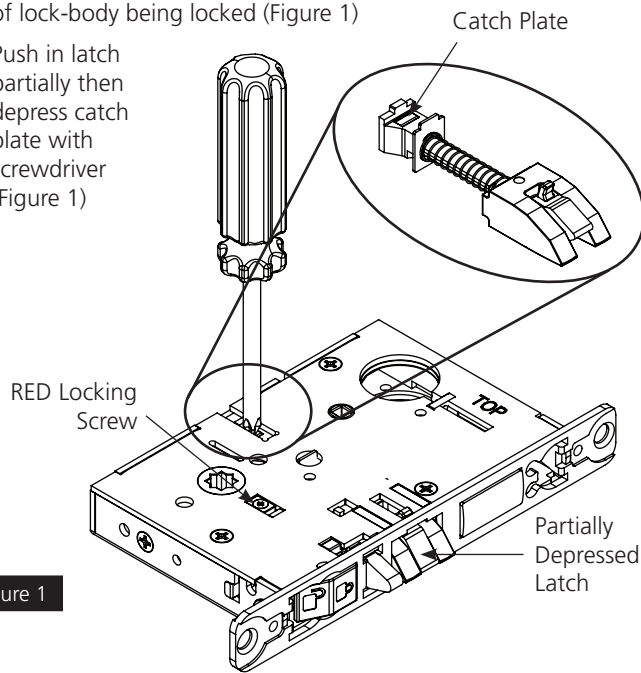

Figure 1

3. Pull latch out of lock-body and rotate 180 degrees (Figure 2)

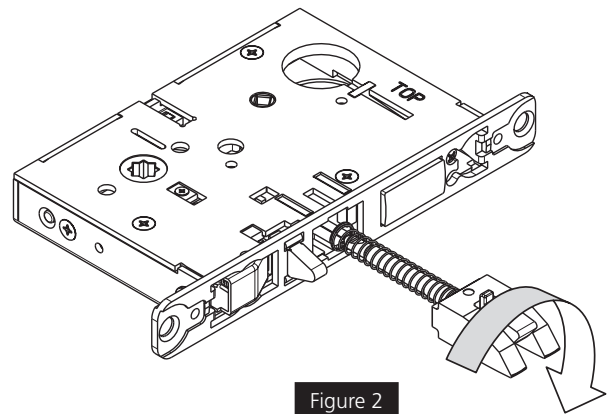

Figure 2

4. Push in latch until tail-piece hits back of case (Figure 3)

**Note: Make sure catch plate is even with top surface and locking pin is not projected (Figure 4). If not, depress catch plate with screwdriver and repeat step 4.**

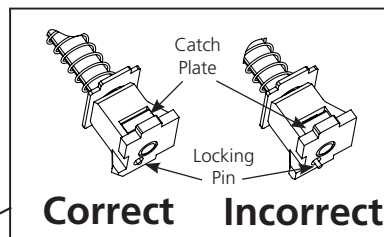

Figure 4

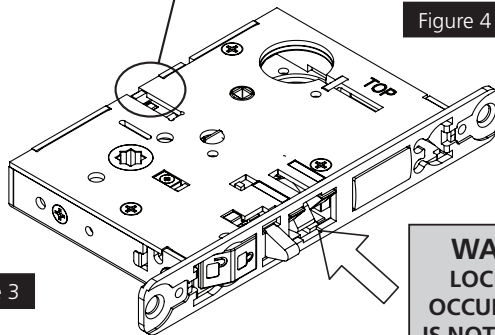

Figure 3

**WARNING:  
LOCK-IN CAN  
OCCUR IF LATCH  
IS NOT PROPERLY  
INSTALLED**

5. Rotate lock front to match bevel of door as shown (Figure 5)

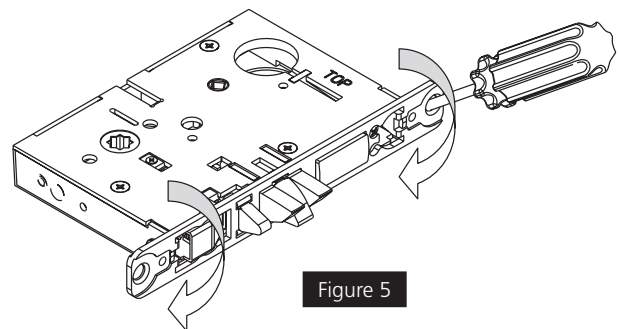

Figure 5

The ASSA ABLOY Group is the global leader in access solutions. Every day, we help billions of people experience a more open world.

ASSA ABLOY Opening Solutions leads the development within door openings and products for access solutions in homes, businesses and institutions. Our offering includes doors, frames, door and window hardware, locks, perimeter fencing, access control and service.



For additional information, contact your  
ASSA ABLOY Door Security Solutions  
sales consultant or  
visit [www.corbinruswin.com](http://www.corbinruswin.com).

**In U.S.**

Corbin Russwin  
Architectural Hardware  
225 Episcopal Road  
Berlin, CT 06037  
Phone: 800-543-3658  
Fax: 800-447-6714  
[www.corbinruswin.com](http://www.corbinruswin.com)

**In Canada**

ASSA ABLOY Door  
Security Solutions Canada  
160 Four Valley Drive  
Vaughan, Ontario  
Canada L4K 4T9  
Phone: 800-461-3007  
Fax: 800-461-8989  
[www.assaabloydss.ca](http://www.assaabloydss.ca)

ASSA ABLOY Group companies offer MicroShield<sup>®</sup>, an antimicrobial coating for door hardware. MicroShield uses proven silver ion-based technology from Agion<sup>®</sup>, a leading provider of antimicrobial solutions, to stem the spread of bacteria and other microbes.

MicroShield<sup>®</sup> is a trademark of ASSA ABLOY Access and Egress Hardware Group, Inc.



The Agion antimicrobial is not intended as a substitute for good hygiene. Coated products must still be cleaned to ensure the surfaces will be free of destructive microbes. ASSA ABLOY makes no representations or warranties, express or implied, as to the efficacy of the Agion antimicrobial. A copy of the Agion warranty is available upon request. Agion is a registered trademark of Agion Technologies, Inc., Wakefield, MA, USA.